

# LTC 8100, LTC 8200, LTC 8300 Series



Security Systems

EN | Instruction Manual  
Allegiant  
Microprocessor-based  
Switcher/Control  
Systems

**BOSCH**

## Important Safeguards

1. **Read, Follow, and Retain Instructions** - All safety and operating instructions should be read and followed before operating the unit. Retain instructions for future reference.
2. **Heed Warnings** - Adhere to all warnings on the unit and in the operating instructions.
3. **Attachments** - Attachments not recommended by the product manufacturer should not be used, as they may cause hazards.
4. **Installation Cautions** - Do not place this unit on an unstable stand, tripod, bracket, or mount. The unit may fall, causing serious injury to a person and serious damage to the unit. Use only manufacturer-recommended accessories, or those sold with the product. Mount the unit per the manufacturer's instructions. Appliance and cart combination should be moved with care. Quick stops, excessive force, or uneven surfaces may cause the appliance and cart combination to overturn.
5. **Cleaning** - Unplug the unit from the outlet before cleaning. Follow any instructions provided with the unit. Generally, using a damp cloth for cleaning is sufficient. Do not use liquid cleaners or aerosol cleaners.
6. **Servicing** - Do not attempt to service this unit yourself. Opening or removing covers may expose you to dangerous voltage or other hazards. Refer all servicing to qualified service personnel.
7. **Damage Requiring Service** - Unplug the unit from the main AC power source and refer servicing to qualified service personnel under the following conditions:
  - When the power supply cord or plug is damaged.
  - If liquid has been spilled or an object has fallen into the unit.
  - If the unit has been exposed to water and/or inclement weather (rain, snow, etc.).
  - If the unit does not operate normally, when following the operating instructions. Adjust only those controls specified in the operating instructions. Improper adjustment of other controls may result in damage, and require extensive work by a qualified technician to restore the unit to normal operation.
  - If the unit has been dropped or the cabinet damaged.
  - If the unit exhibits a distinct change in performance, this indicates that service is needed.
8. **Replacement Parts** - When replacement parts are required, the service technician should use replacement parts specified by the manufacturer, or that have the same characteristics as the original part. Unauthorized substitutions may result in fire, electrical shock, or other hazards.
9. **Safety Check** - Upon completion of servicing or repairs to the unit, ask the service technician to perform safety checks to ensure proper operating condition.
10. **Power Sources** - Operate the unit only from the type of power source indicated on the label. If unsure of the type of power supply to use, contact your dealer or local power company.
  - For units intended to operate from battery power, refer to the operating instructions.
  - For units intended to operate **with External Power Supplies**, use only the recommended approved power supplies.
  - For units intended to operate with a limited power source, this power source must comply with EN60950. Substitutions may damage the unit or cause fire or shock.
  - For units intended to operate at 24VAC, normal input voltage is **24VAC**. Voltage applied to the unit's power input should not exceed 30VAC. User-supplied wiring, from the 24VAC supply to unit, must be in compliance with electrical codes (Class 2 power levels). Do not ground the 24VAC supply at the terminals or at the unit's power supply terminals.
11. **Coax Grounding** - If an outside cable system is connected to the unit, ensure that the cable system is grounded. U.S.A. models only--Section 810 of the National Electrical Code, ANSI/NFPA No.70, provides information regarding proper grounding of the mount and supporting structure, grounding of the coax to a discharge unit, size of grounding conductors, location of discharge unit, connection to grounding electrodes, and requirements for the grounding electrode.
12. **Grounding or Polarization** - This unit may be equipped with a polarized alternating current line plug (a plug with one blade wider than the other). This safety feature allows the plug to fit into the power outlet in only one way. If unable to insert the plug fully into the outlet, try reversing the plug. If the plug still fails to fit, contact an electrician to arrange replacement of the obsolete outlet. Do not defeat the safety purpose of the polarized plug. Alternately, this unit may be equipped with a 3-wire grounding plug (a plug with a third pin, for grounding). This safety feature allows the plug to fit into a grounding power outlet only. If unable to insert the plug into the outlet, contact an electrician to arrange replacement of the obsolete outlet. Do not defeat the safety purpose of the grounding plug.
13. **Lightning** - For added protection during a lightning storm, or when this unit is left unattended and unused for long periods of time, unplug the unit from the wall outlet and disconnect the cable system. This will prevent damage to the unit due to lightning and power line surges.

### For Indoor Product

- Water and Moisture** - Do not use this unit near water - for example, in a wet basement, in an unprotected outdoor installation, or in any area classified as a wet location.
- Object and Liquid Entry** - Never push objects of any kind into this unit through openings, as they may touch dangerous voltage points or short out parts that could result in a fire or electrical shock. Never spill liquid of any kind on the unit.
- Power Cord and Power Cord Protection** - For units intended to operate with 230VAC, 50Hz, the input and output power cord must comply with the latest versions of IEC Publication 227 or IEC Publication 245.  
Power supply cords should be routed so they are not likely to be walked on or pinched. Pay particular attention to location of cords and plugs, convenience receptacles, and the point of exit from the appliance.
- Overloading** - Do not overload outlets and extension cords; this can result in a risk of fire or electrical shock.

### For Outdoor Product

**Power Lines** - An outdoor system should not be located in the vicinity of overhead power lines, electric lights, or power circuits, or where it may contact such power lines or circuits. When installing an outdoor system, extreme care should be taken to keep from touching power lines or circuits, as this contact might be fatal. U.S.A. models only - refer to the National Electrical Code Article 820 regarding installation of CATV systems.

### For Rack-mount Product

- Ventilation** - This unit should not be placed in a built-in installation or rack, unless proper ventilation is provided, or the manufacturer's instructions have been adhered to. The equipment must not exceed its maximum operating temperature requirements.
- Mechanical Loading** - Mounting of the equipment in a rack shall be such that a hazardous condition is not achieved due to uneven mechanical loading.



**ATTENTION**  
OBSERVE PRECAUTIONS  
FOR HANDLING  
ELECTROSTATIC SENSITIVE  
DEVICES

#### WARNING:

Electrostatic-sensitive device. Use proper CMOS/MOSFET handling precautions to avoid electrostatic discharge.

**NOTE:** Grounded wrist straps must be worn and proper ESD safety precautions observed when handling the electrostatic-sensitive printed circuit boards.



#### CAUTION: Lithium Battery

Danger of explosion if battery is incorrectly replaced. Replace only with the same or equivalent type recommended by the manufacturer. Dispose of used batteries according to the battery manufacturer's instructions.

### Cover Removal



**WARNING:** Removal of the cover should only be performed by qualified service personnel - not user serviceable. The unit should always be unplugged before removing the cover and remain unplugged while the is removed.

## Safety Precautions



#### CAUTION

RISK OF ELECTRIC  
SHOCK. DO NOT OPEN!



**CAUTION: TO REDUCE THE RISK OF ELECTRIC SHOCK, DO NOT REMOVE COVER (OR BACK). NO USER SERVICEABLE PARTS INSIDE. REFER SERVICING TO QUALIFIED SERVICE PERSONNEL.**



This symbol indicates the presence of uninsulated "dangerous voltage" within the product's enclosure that can cause an electric shock.



This symbol indicates the presence of important operating and maintenance (servicing) instructions in the literature accompanying the appliance.



Installation should be performed by qualified service personnel only in accordance with the National Electrical Code or applicable local codes.



**Power Disconnect.** Units with or without ON-OFF switches have power supplied to the unit whenever the power cord is inserted into the power source; however, the unit is operational only when the ON-OFF switch is in the ON position. The power cord is the main power disconnect for all units.

## FCC & ICES INFORMATION

### (U.S.A. and Canadian Models Only)

This device complies with part 15 of the FCC Rules. Operation is subject to the following two conditions:

- (1) This device may not cause harmful interference, and
- (2) This device must accept any interference received, including interference that may cause undesired operation.



**NOTE:** This equipment has been tested and found to comply with the limits for a Class B digital device, pursuant to Part 15 of the FCC Rules and ICES-003 of Industry Canada. These limits are designed to provide reasonable protection against harmful interference when the equipment is operated in a residential installation. This equipment generates, uses and can radiate radio frequency energy, and if not installed and used in accordance with the instructions, may cause harmful interference to radio communications. However, there is no guarantee that interference will not occur in a particular installation. If this equipment does cause harmful interference to radio or television reception, which can be determined by turning the equipment off and on, the user is encouraged to try to correct the interference by one or more of the following measures:

- Reorient or relocate the receiving antenna.
- Increase the separation between the equipment and receiver.
- Connect the equipment into an outlet on a circuit different from that to which the receiver is connected.
- Consult the dealer, or an experienced radio/TV technician for help.







Intentional or unintentional changes or modifications, not expressly approved by the party responsible for compliance, shall not be made. Any such changes or modifications could void the user's authority to operate the equipment.

The user may find the following booklet, prepared by the Federal Communications Commission, helpful: [How to Identify and Resolve Radio-TV Interference Problems](#). This booklet is available from the U.S. Government Printing Office, Washington, DC 20402, Stock No. 004-000-00345-4.







## Sécurité

	<b>ATTENTION</b> RISQUE D'ÉLECTROCUTION. NE PAS OUVRIR!	
<b>ATTENTION : POUR ÉVITER TOUT RISQUE D'ÉLECTROCUTION, N'ESSAYEZ PAS DE RETIRER LE CAPOT (OU LE PANNEAU ARRIÈRE). CET APPAREIL NE CONTIENT AUCUN COMPOSANT SUSCEPTIBLE D'ÊTRE RÉPARÉ PAR L'UTILISATEUR. CONFIEZ LA RÉPARATION DE L'APPAREIL À DU PERSONNEL QUALIFIÉ.</b>		
	Ce symbole signale que le produit renferme une « tension potentiellement dangereuse » non isolée susceptible de provoquer une électrocution.	
	Ce symbole invite l'utilisateur à consulter les instructions d'utilisation et d'entretien (dépannage) reprises dans la documentation qui accompagne l'appareil.	
	Attention : l'installation doit exclusivement être réalisée par du personnel qualifié, conformément au code national d'électricité américain (NEC) ou au code d'électricité local en vigueur.	
	Coupeure de l'alimentation. Qu'ils soient pourvus ou non d'un commutateur ON/OFF, tous les appareils reçoivent de l'énergie une fois le cordon branché sur la source d'alimentation. Toutefois, l'appareil ne fonctionne réellement que lorsque le commutateur est réglé sur ON. Le débranchement du cordon d'alimentation permet de couper l'alimentation des appareils.	

## Sicherheitshinweise

	<b>VORSICHT</b> ELEKTRISCHE SPANNUNG. NICHT ÖFFNEN!	
<b>VORSICHT: UM EINEN ELEKTRISCHEN SCHLAG ZU VERMEIDEN, IST DIE ABDECKUNG (ODER RÜCKSEITE) NICHT ZU ENTFERNEN. ES BEFINDEN SICH KEINE TEILE IN DIESEM BEREICH, DIE VOM BENUTZER GEWARTET WERDEN KÖNNEN. LASSEN SIE WARTUNGSARBEITEN NUR VON QUALIFIZIERTEM WARTUNGSPERSONAL AUSFÜHREN.</b>		
	Das Symbol macht auf nicht isolierte „gefährliche Spannung“ im Gehäuse aufmerksam. Dies kann zu einem elektrischen Schlag führen.	
	Der Benutzer sollte sich ausführlich über Anweisungen für die Bedienung und Instandhaltung (Wartung) in den begleitenden Unterlagen informieren.	
	Achtung! Die Installation sollte nur von qualifiziertem Kundendienstpersonal gemäß jeweils zutreffender Elektrovorschriften ausgeführt werden.	
	Unterbrechung des Netzanschlusses. Geräte mit oder ohne Netzschalter haben Spannung am Gerät anliegen, sobald der Netzstecker in die Steckdose gesteckt wird. Das Gerät ist jedoch nur betriebsbereit, wenn der Netzschalter (EIN/AUS) auf EIN steht. Wenn das Netzkabel aus der Steckdose gezogen wird, ist die Spannungszuführung zum Gerät vollkommen unterbrochen.	

## Precauciones de Seguridad

	<b>ATTENZIONE</b> PERICOLO DI SCOSSA ELETTRICA. NON APRIRE.	
<b>PRECAUCIÓN: PARA DISMINUIR EL RIESGO DE DESCARGA ELÉCTRICA, NO RETIRE LA CUBIERTA (NI LA PARTE POSTERIOR). NO EXISTEN PIEZAS DE RECAMBIO EN EL INTERIOR DEL EQUIPO. EL PERSONAL DE SERVICIO CUALIFICADO SE ENCARGA DE REALIZAR LAS REPARACIONES.</b>		
	Este símbolo indica que existen puntos de tensión peligrosos sin aislamiento dentro de la cubierta de la unidad. Estos puntos pueden constituir un riesgo de descarga eléctrica.	
	El usuario debe consultar las instrucciones de funcionamiento y mantenimiento (reparación) en la documentación que se suministra con el aparato.	
	Atención: la instalación la debe realizar únicamente personal cualificado de conformidad con el National Electric Code o las normas aplicables en su país.	
	Desconexión de la alimentación. Las unidades con o sin interruptores de encendido/apagado reciben alimentación eléctrica siempre que el cable de alimentación esté conectado a la fuente de alimentación. Sin embargo, la unidad sólo funciona cuando el interruptor está en la posición de encendido. El cable de alimentación es la principal fuente de desconexión de todas las unidades.	







## Veiligheidsmaatregelen

	<b>VOORZICHTIG</b> GEVAARVOOR ELEKTRISCHE SCHOK. NIET OPENEN!	
<p><b>VOORZICHTIG: OPEN DE BEHUIZING OF DE ACHTERKANT VAN HET APPARAAT NIET. ZO VERMINDERT U HET RISICO OP ELEKTRISCHE SCHOKKEN. IN HET APPARAAT BEVINDEN ZICH GEEN ONDERDELEN DIE U ZELF KUNT REPAREREN. LAAT SERVICE EN ONDERHOUD UITVOEREN DOOR GEKWALIFICEERD PERSONEEL.</b></p>		
	Dit symbool geeft aan dat er binnen in het apparaat ongeïsoleerde, gevaarlijke spanning aanwezig is die mogelijk elektrische schokken kan veroorzaken.	
	De gebruiker dient de bedienings- en onderhoudsvoorschriften te raadplegen in de documentatie die werd meegeleverd met het apparaat.	
	Attentie: het apparaat mag alleen door gekwalificeerd personeel worden geïnstalleerd. De installatie dient in overeenstemming met de nationale elektrische richtlijnen of de van toepassing zijnde lokale richtlijnen te worden uitgevoerd.	
	Spanning uitschakelen. Apparatuur met of zonder aan-uitschakelaar staat onder spanning zolang de stekker is aangesloten op de wandcontactdoos. De apparatuur is uitsluitend in werking als de aan-uitschakelaar aan staat. Het netsnoer is de "hoofdschakelaar" voor alle apparatuur.	







## Sicurezza

	<b>ATTENZIONE</b> PERICOLO DI SCOSSA ELETTRICA. NON APRIRE.	
<p><b>ATTENZIONE: PER RIDURRE IL RISCHIO DI SCOSSE ELETTRICHE NON RIMUOVERE LA COPERTURA (O IL PANNELLO POSTERIORE). L'UNITÀ NON CONTIENE COMPONENTI INTERNI RIPARABILI DALL'UTENTE. PER QUALSIASI INTERVENTO, RIVOLGERSI A PERSONALE TECNICO QUALIFICATO.</b></p>		
	Questo simbolo indica la presenza di "tensione pericolosa" non isolata all'interno del contenitore del prodotto. Ciò comporta un potenziale rischio di scosse elettriche.	
	Si consiglia di consultare le istruzioni operative e di manutenzione (interventi tecnici) contenute nella documentazione fornita con il dispositivo.	
	Attenzione: l'installazione deve essere effettuata esclusivamente da personale tecnico qualificato in conformità con il National Electrical Code o con le normative locali vigenti.	
	Scollamento dell'alimentazione. Le unità dotate o sprovviste di interruttori ON-OFF vengono alimentate quando si inserisce il cavo nella presa dell'alimentazione. L'unità è tuttavia in funzione solo quando l'interruttore ON-OFF si trova nella posizione ON. Il cavo di alimentazione costituisce il dispositivo di scollamento dell'alimentazione principale per tutte le unità.	

## Medidas de Segurança

	<b>CUIDADO</b> RISCO DE CHOQUE ELÉCTRICO. NÃO ABRIR!	
<p><b>CUIDADO: PARA REDUZIR O RISCO DE CHOQUE ELÉCTRICO, NÃO RETIRE A TAMPA (OU A PARTE POSTERIOR). NO INTERIOR, NÃO EXISTEM PEÇAS QUE POSSAM SER REPARADAS PELO UTILIZADOR. REMETA A ASSISTÊNCIA PARA OS TÉCNICOS QUALIFICADOS.</b></p>		
	Este símbolo indica a presença de "tensão perigosa" não isolada dentro da estrutura do produto, o que pode constituir risco de choque eléctrico.	
	O utilizador deve consultar as instruções de funcionamento e manutenção (assistência) nos documentos que acompanham o aparelho.	
	Atenção: a instalação deve ser executada apenas por técnicos qualificados da assistência, de acordo com o código eléctrico nacional ou os códigos locais aplicáveis.	
	Corte de corrente. As unidades com ou sem interruptores ON-OFF (ligar/desligar) recebem corrente sempre que o fio de alimentação está introduzido na fonte de alimentação; contudo, a unidade apenas está operacional quando o interruptor ON-OFF está na posição ON. O fio de alimentação destina-se a desligar a corrente em todas as unidades.	

## Zasady Bezpieczeństwa

	<b>UWAGA</b> NIEBEZPIECZENSTWO PORAZENIA PRĄDEM ELEKTRYCZNYM. NIE OTWIERAĆ!	
<p><b>PRZESTROGA: ABY ZMNIJSZYĆ RYZYKO PORAZENIA ELEKTRYCZNEGO, NIE NALEŻY ZDEJMOWAĆ POKRYWY GÓRNEJ (ani tylnej). WEWNĄTRZ URZĄDZENIA NIE MA ŻADNYCH ELEMENTÓW, KTÓRE MOGĄ BYĆ NAPRAWIANE SAMODZIELNIE PRZEZ UŻYTKOWNIKA. SERWIS NALEŻY ZLECAĆ WYKWALIFIKOWANYM PRACOWNIKOM OBSŁUGI.</b></p>		
	Ten symbol wskazuje na obecność nieizolowanego „niebezpiecznego napięcia” we wnętrzu urządzenia. Napięcie to grozi porażeniem elektrycznym.	
	Użytkownik powinien zapoznać się z instrukcjami obsługi i konserwacji (serwisu), zamieszczonymi w dokumentacji towarzyszącej urządzeniu.	
	Uwaga: Instalacja może być wykonywana wyłącznie przez wykwalifikowanych pracowników obsługi, zgodnie z zasadami kodeksu National Electrical Code lub innych obowiązujących norm.	
	Odłączanie zasilania Niezależnie od wyposażenia w wyłącznik zasilania, prąd do urządzenia jest doprowadzany zawsze, gdy przewód zasilania jest podłączony do źródła zasilania; jednak urządzenie działa tylko wtedy, gdy wyłącznik zasilania jest włączony. Przewód zasilania jest głównym wyłącznikiem zasilania we wszystkich urządzeniach.	

## Table of Contents

Important Safeguards	2
FCC & ICES Information	4
1.0 UNPACKING	8
1.1 Parts List	8
2.0 SERVICE	8
3.0 DESCRIPTION	8
4.0 ALLEGIANT FEATURE SUMMARY TABLE	10
5.0 SYSTEM ACCESSORY COMPONENTS	11
5.1 Alarm Interface	11
5.2 Signal Distribution	11
5.3 IntuiKey Keyboard	11
5.4 LTC 8555/00 & LTC 8555/01 Series Keyboards	11
5.5 LTC 8555/02 & LTC 8555/03 Series Keyboards	11
5.6 KBD-Rack Keyboard Mounting Kit	12
5.7 LTC 8558/00 Keyboard Extension Cable	12
5.8 LTC 8557 Series Keyboard Extension Kits	12
5.9 LTC 8560 Series Receiver/Driver Units	12
5.10 AutoDome Series	12
5.11 LTC 8569, LTC 8570, LTC 8571, LTC 8572 Series Code Merger Unit	12
5.12 LTC 8770 Switcher Follower Series	12
5.13 LTC 8712 Series Console Port Expander Units	12
5.14 LTC 8780 Series Data Converter Units	12
5.15 LTC 8785 Series Code Converters	13
5.16 LTC 8782 Series Code Translator Units	13
5.17 LTC 8808/00 Video Interconnect Panel	13
5.18 LTC 8059/00 Series Allegiant Master Control Software for Windows	13
5.19 LTC 8850/00 Windows Based Graphical User Interface Allegiant Software	13
5.20 Logging Printer	13
6.0 INSTALLATION PROCEDURE	16
6.1 Internal Selections	16
6.2 Enclosure Mounting	16
6.3 Cover Removal	16
6.4 Termination Practices	17
6.5 Looping Video Connections	18
6.6 Keyboard Hookup	18
6.7 Biphase Control Code Output Connections	18
6.8 External Alarm Connections	18
6.9 Satellite Configuration Installations	19
6.10 Feature Selection	22
6.11 Main Power Connections	22
7.0 OPTIONAL ACCESSORIES	24
7.1 Logging Printer Option Installation	24
7.2 Windows Compatible Computer Interface Installation	24



8.0	VIDEO MONITOR DISPLAY	.25
8.1	Time/Date	.25
8.2	Monitor Title/System Status Display	.26
8.3	Monitor Message	.27
8.4	Broadcast Message	.27
8.5	Program Prompts	.27
8.6	Camera Number	.28
8.7	Camera Title	.28
8.8	Video Loss Detection	.28
9.0	FACTORY DEFAULT SETTINGS	.28
9.1	User Selectable DIP Switch Settings for System Configuration Options	.28
10.0	USER INFORMATION	.30
10.1	User Priority Access Table	.30
11.0	ALARM INFORMATION	.31
11.1	Basic Alarm Response Mode	.31
11.2	Auto-Build Alarm Response Mode	.31
11.3	Sequence & Display Alarm Response Mode	.31
11.4	Alarm Activated Pre-Position	.31
11.5	Sample Alarm Responses	.32
12.0	KEYBOARD OPERATION	.34
12.1	General	.34
12.2	System Commands	.34
12.3	Switcher Commands	.34
12.4	Controlling Camera Movement	.34
12.5	Alarm Commands	.36
12.6	Sequence Control	.37
12.7	Sequence Programming	.38
13.0	KEYBOARD USER FUNCTIONS	.40
13.1	General	.40
14.0	MAINTENANCE INFORMATION	.48
14.1	Cleaning The Keyboard	.48
14.2	Replacement of Memory Backup Batteries	.48
15.0	CHARACTER ROM TABLES	.49
16.0	ERROR MESSAGES	.51
17.0	TROUBLESHOOTING GUIDE	.53
18.0	GLOSSARY OF TERMS	.55
APPENDIX A	SATELLITE SYSTEMS	.56
APPENDIX B	INSTALLATION CHECKLISTS	.59
APPENDIX C	QUICK REFERENCE CABLE INTERCONNECTIONS	.60
APPENDIX D	REAR PANEL CONNECTOR PINOUTS	.61

## 1.0 UNPACKING

This equipment should be unpacked and handled with care. If an item appears to have been damaged in shipment, notify the shipper.

Verify that all parts shown in the *Parts List* have been included. If any items are missing, notify your Bosch Security Systems Sales or Customer Service Representative.

The original packing carton is the safest container in which to transport the unit. Save it for possible future use.

### 1.1 Parts List

Qty	Item
1	LTC 8100, LTC 8200, LTC 8300 unit (verify model number)
2	AC power cords (one for 120 VAC, and one for 220 - 240 VAC)
2	Rack-mount brackets LTC 8100 and LTC 8200 only (LTC 8300 has brackets attached)
1	Rear connectors
1	Offset screwdriver
1	This installation manual

## 2.0 SERVICE

If the unit needs repair, contact the nearest Bosch Security Systems Service Center for authorization to return and shipping instructions.

### Service Centers

#### USA

Phone: 800-366-2283 or 717-735-6638

Fax: 800-366-1329 or 717-735-6639

#### CCTV Spare Parts

Phone: 800-894-5215 or 408-956-3853 or 3854

Fax: 408-957-3198

E-mail: [BoschCCTVparts@ca.slr.com](mailto:BoschCCTVparts@ca.slr.com)

#### Canada

Phone: 514-738-2434

#### Europe, Middle East & Asia Pacific Region

Phone: 32-1-440-0711

For additional information, see

[www.boschsecurity.com](http://www.boschsecurity.com).

## 3.0 DESCRIPTION

The LTC 8100 Series, LTC 8200 Series, and LTC 8300 Series Allegiant video switcher/control systems combine both switching and computer technology to provide powerful performance and unique system features for the security user. Offering full matrix switching capability, these systems can be programmed to display the video from any camera on any monitor, either manually or via independent automatic switching sequences.

The LTC 8100 Series provide 8 camera inputs, 2 monitor outputs, 2 keyboards, 8 direct connect alarm input points, an integral signal distribution unit, and a computer interface port.

The LTC 8200 Series provide 16 camera inputs, 5 monitor outputs, 4 keyboards, 16 direct connect alarm input points, an integral signal distribution unit, and a computer interface port.

The LTC 8300 Series provide 32 camera inputs, 6 monitor outputs, 4 keyboards, 32 direct connect alarm input points, an integral signal distribution unit, a computer interface port, and a logging printer port.

These systems can be programmed with up to 60 sequences which can be run independently of each other, in either a forward or reverse direction. Any of the sequences can utilize the SalvoSwitching capability where any number of system monitors may be selected to switch as a group. Using the optional LTC 8059/00 Master Control Software (MCS) for Windows® package or the LTC 8850/00 Bosch Graphical User Interface (GUI) with Allegiant Server, sequences can be made to activate and deactivate automatically, based upon the time of day and the day of week.

Using the LTC 8100, LTC 8200, or LTC 8300 Series integral signal distribution ports, connections to on-site receiver/drivers are easily made. On-site receiver/drivers provide operator control of pan, tilt, zoom, multiple pre-positions, four auxiliaries, autopan, and random scan. The series also supports variable speed operation and full programming functions of AutoDome Series dome cameras.



With its built-in alarm interface capability, an external contact closure or logic level can be used to automatically display any camera. Any monitor or group of monitors can be set to display cameras under alarm conditions. The base system contains three built-in alarm response modes: **basic**, **auto-build**, and **sequence and display**. In addition to these three modes, the PC based software packages offer VersAlarm - a new dimension in alarm handling. VersAlarm has the ability to combine any or all three standard modes. Alarm video may be selected to reset either manually or automatically. In addition, a 16 character alarm title can be selected to appear instead of the camera title during alarm conditions.

System operation and programming is accomplished using a full-function, ergonomically designed keyboard. Multiple keyboards may be used in the system. Built-in operator priority levels and the ability to restrict certain operators from controlling designated functions provide maximum flexibility.

The LTC 8100, LTC 8200, and LTC 8300 Series includes a black outlined 48 character on-screen display for time-date, camera number, camera ID (16 characters), and monitor (12 characters) or status information. When programming camera ID and monitor titles, 235 different characters are available.

Enhanced programming and switching features can be obtained by utilizing a standard Windows equipped PC and the optional LTC 8059/00 MCS for Windows package or LTC 8850/00 GUI software. A user-friendly spreadsheet format provides the ability to enter camera titles, enter operator names, schedule 64 timed events, change system parameters, program camera sequences, install lockouts, and access the advanced VersAlarm alarm handling screens with speed and efficiency. The programmed information may then be transferred into the Allegiant system, stored on disk, or printed from a PC.

The LTC 8850/00 Bosch GUI software is designed around an intuitive graphic-based interface. The GUI provides high performance programming, control and monitoring of all system functions by using on-screen icons to reflect real time status of the devices controlled by the system.

The LTC 8850/00 GUI software also provides the ability to monitor system status events. System alarms, switching functions, sequence events, keyboard actions, and video loss information can be viewed in real time on the PC screen and, if desired, logged to the PC hard drive.

The LTC 8850/00 GUI software can also be used to enable a special on-screen icon for identifying controllable cameras.

The CPU inside these matrix switchers supports powerful macro capabilities. The macros can be activated using system keyboards, system time event functions, alarm activations, and via special function icons in the LTC 8850/00 GUI software.

The LTC 8100, LTC 8200, or LTC 8300 Series can serve as the master switcher in a SatelliteSwitch configuration. This innovative SatelliteSwitch feature enables a single LTC 8100, LTC 8200, or LTC 8300 Series system to communicate with remotely located "Satellite" systems. Any Allegiant system model can serve as a remote Satellite switcher. This powerful feature permits the design of a distributed matrix video switching system with control at one central location and individual control at the local sites. The main control site can view/control local cameras plus cameras located at any of the remotely distributed Satellite sites. The Satellite sites can view/control only cameras associated with their own site. When these models are used in this type of configuration, the main system can access up to 256 cameras located anywhere in the system.

## 4.0 ALLEGIANT FEATURE SUMMARY TABLE

The Allegiant LTC 8100, LTC 8200, and LTC 8300 Series system are available in two operating configurations: a base system and the base system with an optional PC based software package. The base system includes features required for most switching/controller systems.

The addition of the optional LTC 8059/00 MCS for Windows or optional LTC 8850/00 GUI software package enables the user to customize the system's configuration using a menu driven program run on any personal computer using Microsoft® Windows 95, 98 SE, ME, NT, 2000, or XP. The following TABLE lists available features.

	Feature	Base Allegiant System	With Optional PC-Based Software
1.	Full camera switching/control on all monitors	Y	Y
2.	Up to 4 (LTC 8300 and LTC 8200) or 2 (LTC 8100) external keyboards	Y	Y
3.	32 Alarm inputs (LTC 8300), 16 alarms (LTC 8200), 8 alarms (LTC 8100)	Y	Y
4.	3 User-selectable pre-defined alarm response modes	Y	Y
5.	Full control of on-site receiver/drivers	Y	Y
6.	SalvoSwitching	Y	Y
7.	60 Programmable sequences	Y	Y
8.	Alarm call-up of pre-position scenes	Y	Y
9.	RS-232 Interface port for Computer (all models), Logging Printer (LTC 8300 only)	Y	Y
10.	Keyboard logon/logoff function	Y	Y
11.	User-selectable password security	Y	Y
12.	16 Character camera titles and 12 character monitor titles	Y	Y
13.	Format selection time/date format	Y	Y
14.	Local keyboard test function	Y	Y
15.	Table and Sequence printout feature (LTC 8300 only)	Y	Y
16.	Parameter designation for RS-232 communication	Y	Y
17.	Integral video loss detection	N	Y
18.	Satellite configurations	N	Y
19.	Restrict user/keyboard access to cameras	N	Y
20.	Restrict user/keyboard access to receiver/drivers	N	Y
21.	Restrict user access to keyboard	N	Y
22.	Restrict user/keyboard access to monitors	N	Y
23.	Designate user name and ID number	N	Y
24.	Designate zoned alarm call-ups	N	Y
25.	VersAlarm alarm feature	N	Y
26.	Designate displayed camera number	N	Y
27.	Designate receiver/driver functions on alarm	N	Y
28.	Program 64 Time Activated Events	N	Y
29.	Designate receiver/driver functions in sequences	N	Y
30.	Broadcast monitor messages	N	Y
31.	Alarm title designation	N	Y
32.	Personal computer displayed monitoring of system status	N	Y
33.	Personal computer emulation of system keyboard	N	Y

In addition, the LTC 8100, LTC 8200, and LTC 8300 Series systems provide the capability to control on-site receiver/driver units and the AutoDome Series of integral pan/tilt/zoom/camera dome series.

The LTC 8300 Series systems contain a logging printer output port, to which an inexpensive RS-232 serial printer may be attached. This provides a permanent record showing time and date of changes to system status, such as:

1. Incoming Alarms
2. Acknowledgment of alarms by users
3. Loading sequences
4. User logon to keyboard or console port
5. Console broadcast message
6. Console transfer of system tables
7. Activation of Time Event Functions
8. Power up reset message
9. Video loss message

The printer may also be used to provide a hard copy of all system configuration Tables and Sequences.

If a logging printer port is required for the LTC 8200 or LTC 8100 Series system, the console port can be converted to operate in this mode via DIP switch configuration, or by the appropriate command via Command Console Language (CCL). Refer to the CCL manual available for download from our web site for details.

If a logging printer and a standard console port are required for the LTC 8200 or LTC 8100 Series systems, an LTC 8712 Series Console Port Expander can be used to add additional console ports to the system.

## 5.0 SYSTEM ACCESSORY COMPONENTS

The Allegiant Series accessory products provide many optional features to the base system. A brief description of accessory products is provided below. Complete specification information can be found in respective product data sheets. Applicable accessories are designed to be compatible throughout the Allegiant Series.

### 5.1 Alarm Interface

These systems contain an integral 32 (LTC 8300), 16 (LTC 8200), or 8 (LTC 8100) input alarm input capability. The series also provides 6 (LTC 8300), 5 (LTC 8200), or 2 (LTC 8100) alarm output relays for connecting external alerting devices or VCRs. The separate LTC 8540/00 Alarm Interface accessory is not applicable to the LTC 8100, LTC 8200, or LTC 8300 Series.

### 5.2 Signal Distribution

The series contain an integral signal distribution unit for communicating to Receiver/Drivers, Switcher Followers, and Satellite systems. The integral unit provides 16 (LTC 8300), 12 (LTC 8200), or 8 (LTC 8100) outputs, each capable of driving up to 8 remote devices. Either **star** or **daisy chain** wiring configurations may be used. The separate LTC 8568/00 and LTC 8768/00 Signal Distribution accessory units, are not applicable to the series.

### 5.3 IntuiKey Keyboard

This full-function, multipurpose keyboard is used for system control and programming, and includes integral pan/tilt/zoom joystick and a splash resistant design. The IntuiKey's LCD displays and softkeys provide a menu driven system for ease of use, supporting a multitude of languages.

### 5.4 LTC 8555/00 and LTC 8555/01 Series Keyboards

These full-function, compact keyboards are used for system control and programming and include integral pan/tilt joystick with LED readouts to display camera and monitor numbers.

The LTC 8555/01 is identical to the LTC 8555/00, but has ICON characters instead of English text.

### 5.5 LTC 8555/02 and LTC 8555/03 Series Keyboards

These keyboards are similar to the LTC 8555/00 except that RS-232 protocol is used for data communication. These keyboards have the capability of remotely locating an Allegiant keyboard via RS-232 transmission medium such as phone line modems, fiber optics, etc. Requires a full duplex RS-232 link capable of operating at 9600 baud. All other specifications are the same as for the LTC 8555/00 keyboard.

These keyboards connect to an Allegiant's console port or to a port provided by an LTC 8712 Console Expander accessory unit. Up to 4 may be connected to a single LTC 8712 unit. When used with dial-up type phone modems, these keyboards provide rudimentary dialing capability.

The LTC 8555/03 is identical to the LTC 8555/02, but has ICON characters instead of English text.

### **5.6 KBD-Rack Keyboard Mounting Kit**

Rack-mounting kit designed to provide vertical, horizontal, or inclined mounting for IntuiKey keyboards.

### **5.7 LTC 8558/00 Keyboard Extension Cable**

Six-conductor extension cable that carries data/power for remote keyboards up to 30 m (100 ft) away from main CPU bay.

### **5.8 LTC 8557 Series Keyboard Extension Kits**

Interface kit used to remote keyboards up to 1.6 km (5000 ft) away from main CPU bay. Customer-supplied 24 gauge shielded twisted pair (Belden 9841 or equivalent) required between main CPU bay site and keyboard site. Kit provides two junction boxes, interface cable, and appropriate keyboard power supply.

### **5.9 LTC 8560 Series Receiver/Driver Units**

Decodes data transmitted from the biphasic control data outputs of the Allegiant system, for camera site control of Pan/Tilt, Zoom Lens, pre-positions, and auxiliaries. Unit contains integral local test feature, autopan or random scanning, and is available in several input and output drive voltage versions.

### **5.10 AutoDome Series**

Integral camera, high speed pan/tilt, zoom lens, and receiver/driver system in compact dome enclosure. Various enclosure mounting options are available for indoor and outdoor applications.

### **5.11 LTC 8569, LTC 8570, LTC 8571, LTC 8572 Series Code Merger Unit**

Control code merger and line driver unit used to combine control code from two systems (up to four with LTC 8570 model) for communicating to Receiver/Drivers, Switcher Followers, and satellite systems. Provides 32 or 64 outputs capable of driving up to 256 or 512 remote devices. Either **star** or **daisy chain** wiring configurations may be used. Unit will accept signal input either from Allegiant main CPU bay, LTC 8568 output, or an output from another code merger unit. Multiple units may be cascaded to obtain additional outputs.

### **5.12 LTC 8770 Switcher Follower Series**

Accessory unit which provides relay contact closures corresponding to cameras displayed on system monitors. The LTC 8770 may be configured to follow non-alarmed video, alarmed video, or both. Each unit provides 24 relay contact outputs.

### **5.13 LTC 8712 Series Console Port Expander Units**

The LTC 8712 Series port expander interfaces to the RS-232 Console port of an Allegiant system to permit up to 4 external PCs, logging printers, or other computing devices. This permits multiple PCs or computing devices to communicate with a single Allegiant system.

### **5.14 LTC 8780 Series Data Converter Units**

The LTC 8780 Series convert the biphasic control code generated by Allegiant Series matrix switchers into standard RS-232, and converts RS-232 back to biphasic code. This provides transmission of the biphasic control code over conventional RS-232 transmission media (phone modems, fiber optics, microwaves, etc.). The LTC 8780 Series can also be used to perform the Satellite Selector functions in Allegiant satellite system configurations and operate as a 15-channel remote signal distribution unit.

### 5.15 LTC 8785 Series Code Converters

LTC 8785 Series units are designed for use in pre-1996 Allegiant systems which have been upgraded to operate AutoDome Series of cameras. The LTC 8785 Series Code Converters are used to provide the source for the **fixed speed** control code when the system is generating the new **variable speed** control code preferred by the AutoDome cameras. The LTC 8785 Series Code Converter receives the **variable speed** control code from one of the Allegiant Signal Distribution outputs and converts it into the appropriate **fixed speed** control code. Outputs from the LTC 8785 Series Code Converter may be connected to older LTC 8561 Series receiver/drivers using existing field cables.

### 5.16 LTC 8782 Series Code Translator Units

Code translators convert Allegiant control code to and from other manufacturer's code formats. Contact your local manufacturer's representative for additional information.

### 5.17 LTC 8808/00 Video Interconnect Panel

Optional accessory item which provides the LTC 8300 or LTC 8200 Series systems with the capability of looping its video inputs (the LTC 8100 provides integral BNCs for looping so the LTC 8808/00 is not required). This patch panel contains 32 BNC connectors on front for external video connections, and two 16-contact ribbon connectors on the rear. Two 16-conductor ribbon cables are included for interfacing the patch panel to the video looping connectors on the LTC 8300 or LTC 8200 Series equipment bay (only one ribbon cable is used for the LTC 8200). The patch panel is one standard EIA 19-inch rack unit high, and one unit wide.

### 5.18 LTC 8059/00 Series Allegiant Master Control Software for Windows

The LTC 8059/00 Series Allegiant MCS for Windows consists of a Windows NT, Windows 95 or Windows 98 compatible program for configuration of standard system features. The program provides advanced alarm and sequence programming, in addition to other features not available via the system keyboard. Online real time monitoring of system status is also included.

Other standard MCS for Windows features include: user passwords, **lockout** tables, 64 programmable time event functions, and custom alarm responses using the **VersAlarm alarm** mode. In addition to the operational switching sequences entered via standard keyboard, more complex switching sequences may be programmed, to incorporate remote control commands into the switching sequence. Video loss detection in LTC 8100, LTC 8200, and LTC 8300 Series systems and monitoring of all system operation in real-time, are standard features of the Allegiant MCS for Windows package.

### 5.19 LTC 8850/00 Windows Based Graphical User Interface Allegiant Software

The LTC 8850/00 software package uses a GUI to integrate and control security systems. The GUI interfaces directly to the Allegiant system and provides complete control and programming of all system features. Refer to the LTC 8850/00 data sheet for specifications.

### 5.20 Logging Printer

An optional RS-232 serial printer may be connected to the LTC 8300 Series to provide a permanent record of significant system status changes. Time and date is printed for system events such as alarms, start-up after power failure, sequence loading, operator logon/logoff to keyboards, and download of information from the optional MCS for Windows or LTC 8850/00 GUI. The printer may also be used to obtain hard copies of all system Tables and Sequences.

NOTE: The Printer port does not provide a standardized pinout connection. An interface cable designed for a standard serial printer connection is available. If desired, a cable can be made up at installation, by following the cable pinout information provided at the end of this manual.

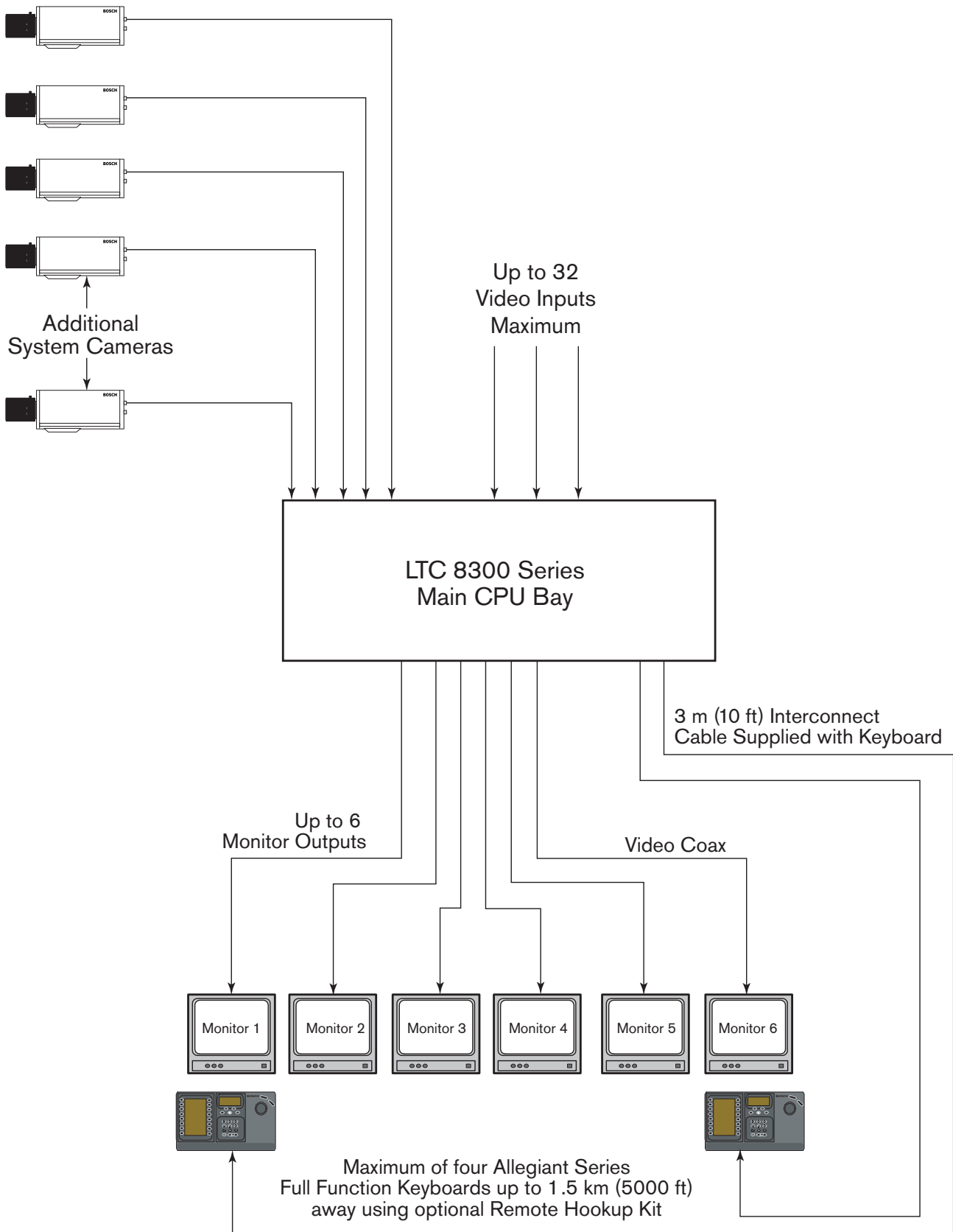

Figure 1 LTC 8300 Series Video Switching System



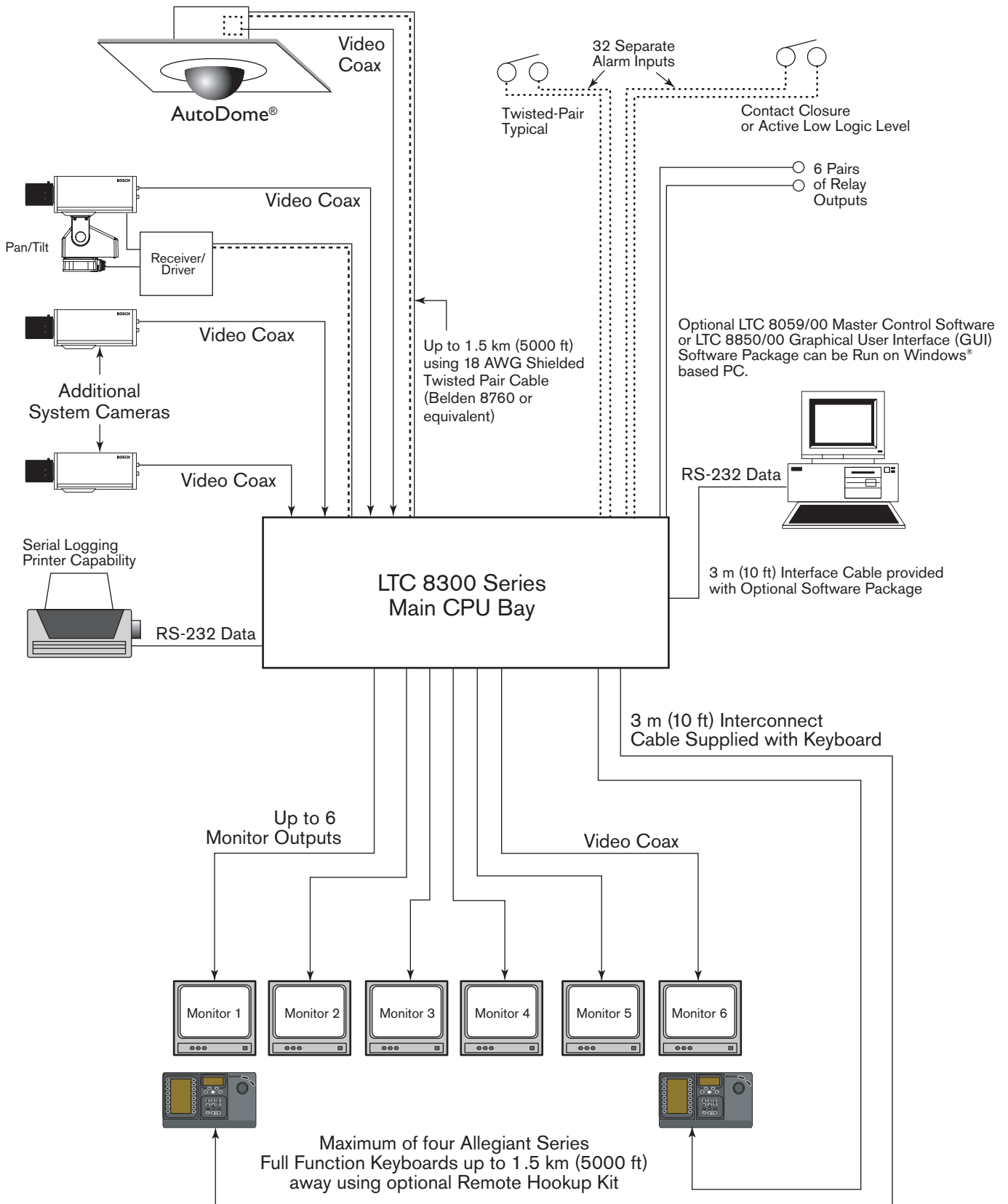

Figure 2 LTC 8300 Series Full Capacity Configuration

## 6.0 INSTALLATION PROCEDURE



**CAUTION:** Do Not Apply Power to Equipment Until Instructed to do so.



**WARNING:**  
Electrostatic-sensitive device. Use proper CMOS/MOSFET handling precautions to avoid electrostatic discharge.

**NOTE:** Grounded wrist straps must be worn and proper ESD safety precautions observed when handling the electrostatic-sensitive printed circuit boards.

### 6.1 Internal Selections

The LTC 8100, LTC 8200, and LTC 8300 Series incorporate printed circuit board(s) (PCB) that contain user-selectable DIP switches. If necessary, follow the instructions in the *COVER REMOVAL Section* below to access the DIP switches. Removal of the cover should only be performed by qualified service personnel.

The LTC 8x00 Series circuit board contains the video input termination switches S0801, S0802, S0803, and S0804 (S0803 and S0804 are only present on the LTC 8300 Series). The video termination switches on the Allegiant must be set to the correct position prior to installation. Read the *TERMINATION PRACTICES Section* prior to installing the system to determine if it is necessary to change the video module termination switches.

The circuit board contains two 8-position DIP switches for system configuration options, and two lithium batteries. The DIP switches can be used to modify certain system operating conditions. Review the *FACTORY DEFAULT SETTINGS Section* to determine if it is necessary to change the DIP switches from the factory default positions.

The circuit board's lithium batteries require attention only when it is necessary to change them. These batteries enable the RAM memory to retain its contents for up to a year without power. Since the batteries are not used while the AC power is on, several years of service should be expected before it becomes necessary to change them.

### 6.2 Enclosure Mounting

If the unit is to be installed into a standard 19-inch EIA rack, remove the four (4) rubber bumper foot pads on the bottom. Four holes are provided for mounting the bay in the rack.

The LTC 8300 is supplied with the rack-mounting brackets attached. The LTC 8200 and LTC 8100 are shipped with the rack-mounting brackets unattached. On these systems, the brackets must be attached prior to being installed into a rack. Use the supplied offset screwdriver to remove the two (2) star head screws located on each side near the front of the unit. Then attach the supplied rack mounting brackets to the unit.

If the LTC 8300 Series are not going to be rack-mounted, the enclosure's mounting brackets can be removed. The cover of the unit must be removed before access to the mounting brackets is possible.

### 6.3 Cover Removal

#### Cover Removal



**WARNING:** Removal of the cover should only be performed by qualified service personnel - not user serviceable. The unit should always be unplugged before removing the cover and remain unplugged while the cover is removed.

Cover removal is necessary only if changes need to be made to the video input termination switches, system configuration DIP switches, or batteries.

For the LTC 8300, the top cover is fastened to the case by 4 screws located on the rear of the unit. For the LTC 8100 and LTC 8200 units, the top cover is fastened by 8 screws on the top and 4 screws on each side. Use the supplied offset screwdriver to remove the star head screws. After the screws have been removed, the cover slides back and off the unit. Reverse procedure to re-install.

### 6.3.1 Mounting Ear Removal

If the LTC 8300 Series is to be used as a desk top unit, remove each mounting ear by removing the screw holding the mounting ear to the enclosure chassis (see *Figure 3*).

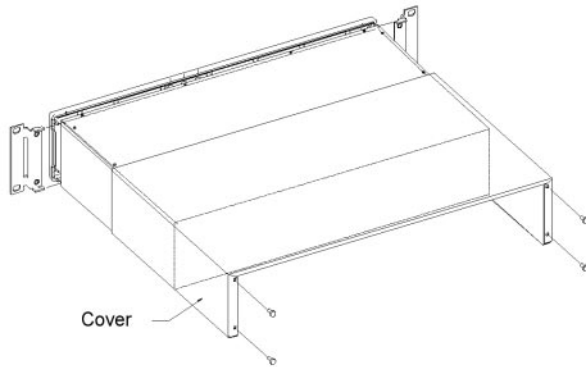

Figure 3 Cover and Rack Brackets Removal

### 6.3.2 Video Termination Selections

The video input termination DIP switches are located toward the rear of the circuit board. Note that the **Factory Default Settings** are all ON (input terminated with 75Ω). Only those switches associated with looping video inputs need to be changed to OFF (unterminated).

### 6.3.3 CPU Module Selections

To access the circuit board, remove the cover and lid as described in the *COVER REMOVAL Section*. The batteries and the two 8-position system configuration DIP switches (S0201 and S0202) near the front of the unit will now be visible. Change only the desired CPU DIP switches based on the features described in the *FACTORY DEFAULT SETTINGS Section* of this manual.

### 6.3.4 Battery Replacement



**CAUTION:** Lithium Battery  
Danger of explosion if battery is incorrectly replaced. Replace only with the same or equivalent type recommended by the manufacturer. Dispose of used batteries according to the battery manufacturer's instructions.

If the batteries have reached the end of their useful life, the Time and Date portion of on-screen display will begin to alternate with an indication of ?? ?? ??. The LED on the front panel of the unit will also light, indicating a low battery condition. Access the circuit board as described in the *INTERNAL SELECTIONS Section* above, then follow the instructions found in the *MAINTENANCE INFORMATION Section* of this manual for replacement procedures.

## 6.4 Termination Practices

Video from every camera should be **terminated** with a 75Ω resistance. Each video line should be terminated exactly once. If video from a camera is going to several devices, only the last device on the video line should be terminated.

### 6.4.1 Video Terminations

The main circuit board has DIP switches to select the termination of each video line. To terminate an input line, ensure that the appropriate DIP switch on the video module is ON (**Factory Default Setting**). If non-terminated operation is required for looping purposes, turn the switch OFF. See the TABLE below to determine the DIP switch numbers that correspond to video input.

Video Inputs	Switch	Switch No.	Systems
1-4	S0801	1-4	LTC 8100, LTC 8200, LTC 8300
5-8	S0802	1-4	LTC 8100, LTC 8200, LTC 8300
9-12	S0801	5-8	LTC 8200, LTC 8300
13-16	S0802	5-8	LTC 8200, LTC 8300
17-20	S0803	1-4	LTC 8300
21-24	S0804	1-4	LTC 8300
25-28	S0803	5-8	LTC 8300
29-32	S0804	5-8	LTC 8300

#### Video Input Termination Switches

If looping video inputs are desired, the LTC 8200 and the LTC 8300 Series require an optional LTC 8808/00 patch panel (for the LTC 8100 Series, the looping BNCs are included on the unit). A single LTC 8808/00 provides looping capability for all 16 (LTC 8200) or 32 (LTC 8300) video inputs. If necessary, refer to the *Section on LOOPING VIDEO CONNECTIONS* below.

Just like camera inputs, monitor outputs on the Allegiant system are designed to be terminated. Each monitor output expects to be connected to a 75Ω load. This is the load typically provided by a monitor. If a monitor output line is **looped** through several monitors or other equipment, ensure that only the last unit on the line is terminated.

## 6.5 Looping Video Connections

The Allegiant Series has outputs available for video input looping connections. Looping connections for LTC 8200 and LTC 8300 require the optional LTC 8808/00 Video Interconnect (patch) Panel. The patch panel provides 32 BNCs for video connections. Patch panels are connected to the rear of the main bay via supplied ribbon cables. Each cable can carry video for up to 16 cameras. For LTC 8300 Series systems, 2 cables can be attached to the patch panel to support up to 32 cameras. Each ribbon cable should be attached to the appropriate VIDEO connector on the rear of the main bay.

### LTC 8808/00 Typical Use

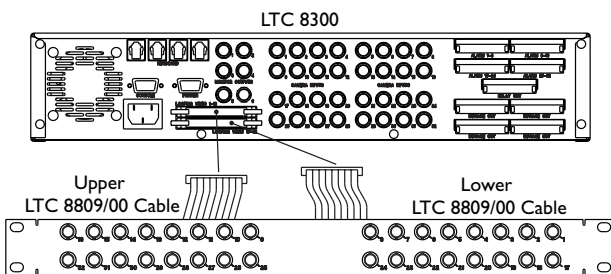

Figure 4 Video Interconnect Panel

## 6.6 Keyboard Hookup

Connect a maximum of 4 (LTC 8300 or LTC 8200 Series) or 2 (LTC 8100 Series) system keyboards to any of the keyboard ports (modular phone type jacks) provided on the rear of the main bay. Be sure to connect a keyboard to at least port #1.

**NOTE:** The LTC 8555 Series RS-232 type keyboards are not connected to the standard keyboard ports. The keyboards connect to the Console port, or to a LTC 8712 Series Port Expander. Note that when LTC 8555 RS-232 type keyboards are connected to the system, the corresponding standard keyboard ports are automatically disabled.

Each keyboard is supplied with a 3 m (10 ft) cable for local hookups. Allegiant systems can provide power to keyboards up to 30 m (100 ft) away via the optional LTC 8558/00 hookup cable. For distances of up to 1.5 km (5000 ft), the optional LTC 8557 Series hookup kit is required. This product is supplied with a remote power pack, and requires user-supplied shielded twisted pair (Belden 9841 or equivalent) for communication.

## 6.7 Biphase Control Code Output Connections

Allegiant systems provide separate outputs (16 for LTC 8300, 12 for LTC 8200, 8 for LTC 8100 Series) for driving remote receiver/drivers, switcher/followers, and satellite systems. Either **star** or **daisy chain** wiring configurations may be used.

Connect shielded twisted pair cable between the camera site receiver/driver locations (or other accessory device) and any of the outputs provided on the Allegiant's rear panel. Use the straight slot side of the supplied offset screwdriver to tighten the terminal block screws. Maximum transmission distance is 1.5 km (5000 ft) using 1 mm<sup>2</sup> (18 AWG) shielded twisted pair (Belden 8760 or equivalent). Contact removable screw terminal blocks are provided with up to 4 separate connection groups per block. Each group provides three connections; +, -, and S (Shield). Do not mix connections between groups, i.e. connecting one wire of the cable to the + of one group and another wire of the same cable to the - of another group. Each output is rated to handle up to 8 receiver/drivers, as in a **daisy chain** configuration, to a maximum of 1.5 km (5000 ft). Select and maintain a wire color convention to avoid confusion at the various camera sites.

Example: White to +, Black to -, and Shield to S.

The CODE OUT LED located on the Allegiant front panel will flash when the joystick, a lens control, or a video switching action is activated. The CODE OUT LED also flashes occasionally when system status information is being generated by the system.

## 6.8 External Alarm Connections

The LTC 8100, LTC 8200, and LTC 8300 Series contain integral alarm input and output connections. These alarm inputs provide automatic display of video under alarm conditions. The units accept up to 32 (LTC 8300), 16 (LTC 8200), 8 (LTC 8100) contact closures or logic level inputs from remote sensing devices (door contacts, PIRs, etc.). The alarm inputs are designed to generate alarm conditions upon closure of the external contacts (normally open contacts). The units also provide 6 (LTC 8300), 5 (LTC 8200), or 2 (LTC 8100) relay closure outputs upon alarm conditions.

Alarm input connections are made to 12 contact removable screw terminal blocks located on the rear panel. Each terminal block provides 8 alarm input connections.

Connect any 2-conductor shielded wire (the shield and ground wire are both connected to the connector pins labeled **G**) between the alarming device (contact closure or logic level) and the appropriate Allegiant input. Use the straight slot side of the supplied offset screwdriver to tighten the terminal block screws. The alarm input numbers are marked on the removable connector block. Note that every two alarm inputs share a common ground connection. The total wire **loop resistance** should not exceed 1,000Ω. Input #1 corresponds to camera #1 in the **Factory Default Settings**, but this relationship can be changed via programming with the optional LTC 8059/00 MCS for Windows package or LTC 8850/00 GUI software package.

Allegiant units also provide isolated alarm relay outputs. An alarm output is typically used to activate the alarm input of a security DVR/VCR or other alerting device. A VCR is normally programmed to change recording speeds from a slower time lapse mode to a faster real time mode upon alarm activation. Operation of the relay outputs depends on the system configuration for responding to alarm events. The alarm output relays activate accordingly under the following conditions:

1. Relay 1 activates if the system is set to use the **Basic alarm response** mode, and an alarm occurs on any system monitor. Relay 1 deactivates after all alarms have been removed from the inputs. Relay 1 also deactivates if the system (monitor or alarm(s)) is disarmed by an operator via the keyboard. Pressing **Acknowledge** on the system keyboard does not deactivate Relay 1 since the alarm video follows the contact applied to the unit in this **alarm response** mode. Other relays are not used in this mode.
2. Relay 1 activates if the base system is set to use the **Sequence & Display alarm response** mode and an alarm occurs on any system monitor. Relay 1 deactivates after all alarm videos have been acknowledged (by pressing the **Acknowledge** key) via system operator(s) from all system monitors. Relay 1 also deactivates if the system is disarmed (either the monitor or the alarm(s)) by an operator via the keyboard. Removal of the alarm input does not deactivate Relay 1 since the alarm video(s) are not dependent on duration of the contact applied to the unit in this alarm response mode. Other relays are not used in this mode.
3. If the base system is set to use the **Autobuild alarm response** mode, and an alarm occurs on system monitors, the relay corresponding to the monitor number activates for the duration that the corresponding alarm input is applied to the unit. The relay deactivates if the monitor associated with the relay or if the alarm(s) being displayed on the monitor is disarmed by an operator via the keyboard. Pressing **Acknowledge** on the system keyboard does not deactivate the relays since the alarm video follows the contact applied to the unit in this **alarm response** mode.
4. If the **VersAlarm Group** table screen in the PC-based LTC 8059/00 MCS for Windows package or the LTC 8850/00 GUI software contains an alarm group that includes monitors, and the **Monitor** option has been selected in the **Relay Action** column, the corresponding relay activates for the duration the alarm video remains on the monitor. The relay deactivates if the associated monitor (or the alarm(s) being displayed on the monitor) is disarmed by an operator via the keyboard. Pressing **Acknowledge** on the system keyboard does not deactivate the relay unless this feature has been selected for the associated alarm group. If the **Monitor** option has been set to **1** in the **Group** table, only Relay 1 activates when monitors in that alarm group become alarmed.

Typically, any 2-conductor wire can be used between the rear panel terminal block containing the relay outputs, and the VCR alarm input. Use the straight slot side of the supplied offset screwdriver to tighten the terminal block screws. If another external device is to be controlled, do not exceed the relay ratings of 1 A, 40 VAC/DC.

## 6.9 Satellite Configuration Installations

Due to many variables, only general guidelines will be covered for installing satellite systems. Refer to the APPENDICES of this manual and either the LTC 8059/00 MCS for Windows or LTC 8850/00 GUI software manual for additional information on satellite systems.



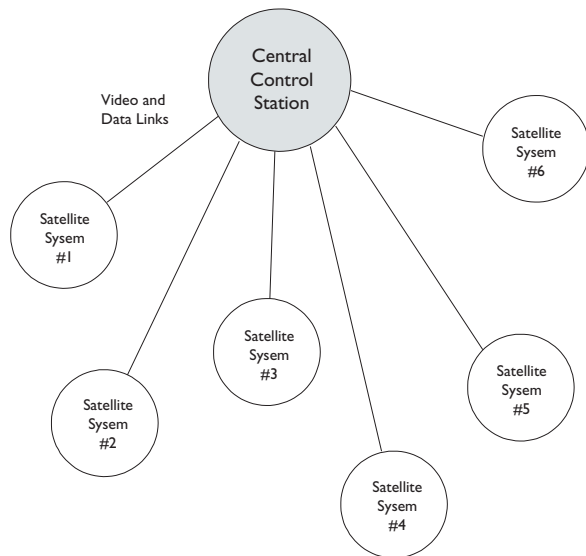

Figure 5 Satellite Concept Configuration

### 6.9.1 Satellite Site Trunk Line Monitor Outputs

At each of the remote satellite sites, a desired number of monitor outputs from the switcher must be assigned as trunk lines. The number of trunk lines can range from 1 to the maximum number of monitor outputs provided by the switcher. Note that the number of trunk lines coming from a satellite site determines the maximum number of cameras from that site that may be viewed simultaneously at the main site. If operators will be stationed at the satellite site, they should be prevented from accessing the monitor outputs designated as trunk lines. This can be accomplished via the **Monitor Lockout** tables in either the LTC 8059/00 MCS for Windows or the LTC 8850/00 GUI software (see below).

### 6.9.2 Main Site Trunk Line Video Inputs

At the main site, video trunk line connections coming from each of the remote site(s) should be connected (and properly terminated) using an available video input at the main bay. There are no programming restrictions concerning their connections, but a sense of order can be maintained if a group of video inputs are used at the upper end of the system's designed capacity. This allows the main system to be more easily expanded in the future with additional local cameras or trunk lines. As an example, assume that there are a total of 8 trunk lines coming from all satellite sites which will be connected to a main site system designed for 32 inputs. Inputs 25 to 32 can be reserved for the trunk lines, leaving inputs 1 to 24 for local camera connections. If there will be no local camera inputs, the trunk lines can start at the first video input.

### 6.9.3 Control Data Lines in Satellite Systems

Each satellite site must be provided with an Allegiant biphasic control data line coming from the Signal Distribution located at the main site. The Signal Distribution unit is an integral part of the LTC 8100, LTC 8200, and LTC 8300 Series. This data line carries all pan/tilt/zoom control commands, in addition to the switching commands generated by the main site switcher. The control data line should be connected to an LTC 8780 Series Data Converter unit, which provides address decoding functions for the satellite site. An LTC 8780 Series is required at each satellite site, and must be given a unique site address number.

If operators stationed at the satellite site are permitted to control pan/tilt/zoom-equipped cameras, an LTC 8569 Series Code Merger unit must be installed at the satellite site. The Code Merger combines code generated by the main site and the satellite sites so both sites have control over pan/tilt/zoom-equipped cameras at the satellite site. The LTC 8780 Series can then be connected to one of the data outputs of the LTC 8569 Series unit.

### 6.9.4 Satellite Site Programming Requirements

The optional LTC 8059/00 MCS for Windows or the optional LTC 8850/00 GUI software is required to properly program a satellite system.

Programming the satellite sites is usually limited to designating their **logical** camera numbers to appropriate values via the **Camera ID** table of the MCS or GUI software.

Note that no duplicate camera numbers are permitted anywhere in the system. Allegiant logical camera designations can be renumbered to any four-digit number on the LTC 8100, LTC 8200, LTC 8300 Series, LTC 8600 Series, LTC 8800 Series, or LTC 8900 Series systems, and any three-digit number on LTC 8500 systems.

Few other restrictions exist. These camera numbers are the numbers entered at both the satellite and the main site keyboards when camera selections are made. On any pan/tilt/zoom-equipped camera, this logical number must also be entered as the receiver/driver's site address number.



To maintain a sense of order, it is preferable to program a satellite for a range of camera numbers. For example, in a three Allegiant type satellite system, the first satellite can be programmed for camera numbers 1 to 50. Satellite two can be programmed for camera numbers 101 to 131, and satellite three can use numbers 201 to 225.

If necessary, the MCS or GUI software **Keyboard-to-Monitor Lockout** table can be programmed in the satellite switcher to prevent any local operators from inadvertently accessing the satellite's monitor outputs being used as trunk lines.

If operators will be stationed at the satellite site, camera titles should be entered into the switcher. If desired, these titles can be selected (explained below) to appear at the main site.

The only other requirement is to ensure that the Console ports of all Allegiant type satellites have the handshake option disabled (CTS = off). This is done via keyboard **User Function 30** (see *Section 13, KEYBOARD USER FUNCTIONS*), the MCS or GUI software's **Parameters-System** screen.

### 6.9.5 Main Site Programming Requirements

At the main site, the **Camera ID** table must be programmed to ensure proper satellite operation. It is easiest to start with the trunk line inputs. For each trunk line, the satellite's monitor output number and its bay address must be entered (same number as the satellite's LTC 8780 address).

Camera numbers should be programmed next. No duplicate camera numbers are allowed anywhere in the entire system. Designate remote cameras (located at satellite sites) using numbers above those at the main bay's physical video inputs (9+ on LTC 8100 Series, 17+ on LTC 8200 Series, 33+ on LTC 8300 Series, 65+ on LTC 8500, 129+ on LTC 8600, 257+ on LTC 8800 Series, 4097+ on LTC 8900 Series). Enter the desired camera number, (the satellite bay that it is actually connected to), and select if either a local title will be used, or if the remotely generated title will be used. For satellite camera entries, only those numbers representing actual cameras need to be entered. For example, all 16 cameras associated with an LTC 8200 switcher do not need to be entered if only 5 cameras are actually connected to the switcher. If desired, a few extra camera numbers may be included at this time for future expansion. If a local title is specified, the camera's title can also be entered at this time. Designate any local camera numbers appropriately, and enter their corresponding titles.

NOTE: Either a local camera, or a remote camera programmed with a local title, will need to be selected to view certain on-screen prompts or data during programming of the main site via a system keyboard.

Once the system is programmed and configured, any unused monitor outputs located at the main site should be selected to display a local camera via the system keyboard. This prevents unused monitor outputs from using up trunk lines which may result in some confusing operational responses.

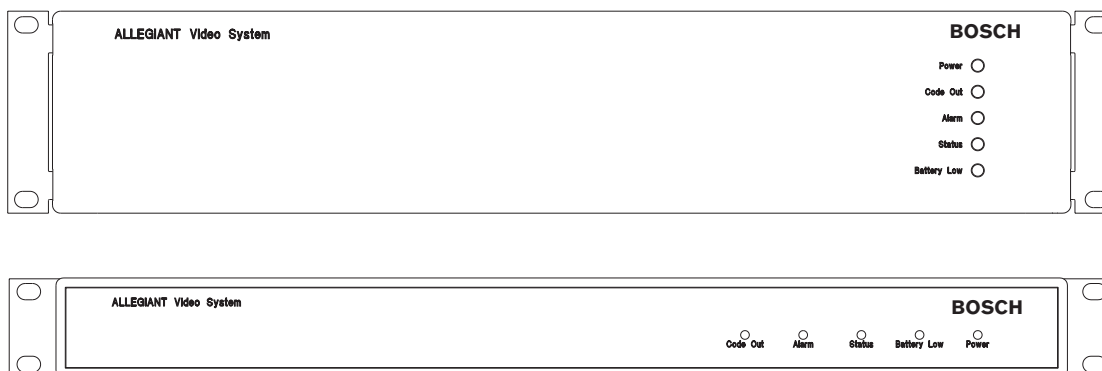

Figure 6 Front Panels: LTC 8300 Series - Top, LTC 8200 Series, LTC 8100 Series - Bottom

### 6.9.6 Alarm Inputs in Satellite Systems

Any alarm inputs to the main site, which have been programmed to activate cameras located at satellites, will operate normally except when limited by the number of trunk lines available. The software automatically determines trunk usage depending on the priority level of operators currently viewing satellite cameras. Alarm inputs applied at a satellite site will **NOT** activate alarm video at the main site. If the application requires alarms located at a satellite to activate video at the main site, the remote alarms must be brought back to the main site. If necessary, the main site's LTC 8540/00 Alarm Interface unit can be remotely located via an RS-232 link. Since the Alarm Interface capability is an integral part of the LTC 8100, LTC 8200, and LTC 8300 Series, this is not possible if an LTC 8100, LTC 8200, or LTC 8300 Series system is being used as the main site system. If more than one satellite site contains alarms, multiple LTC 8540/00 Alarm Interfaces can be remotely located. The number of alarm interfaces which can be remoted is limited only by the capacity of the main site system to support this capability.

### 6.10 Feature Selection

Certain user-selectable features can provide enhanced Allegiant system operation capabilities. Any changes involving configuration option DIP Switch Settings should be made prior to installation. Refer to *FACTORY DEFAULT SETTINGS Section* for feature descriptions and instructions.

### 6.11 Main Power Connections

Connect the AC power cord to an appropriate AC power source. Verify that the selected LTC 8100, LTC 8200, or LTC 8300 Series model matches the desired voltage input.

#### NOTES:

- The system may require several seconds to fully initialize after a power up reset. This time can vary based on the activity and general size of the system. Verify that the front panel **POWER** LED lights and the front panel **STATUS** LED begin to blink randomly.
- ALL CAMERAS SHOULD BE PHASED PROPERLY WITH EACH OTHER TO AVOID VERTICAL ROLLING MONITOR DISPLAY DURING SWITCHING.
- THE SYSTEM IS DESIGNED TO PROVIDE VERTICAL SYNCHRONIZED SWITCHING BASED ON THE MAIN VOLTAGE INPUT FREQUENCY.

Proceed to the next applicable accessory installation section or immediately to the appropriate system operating instruction section.

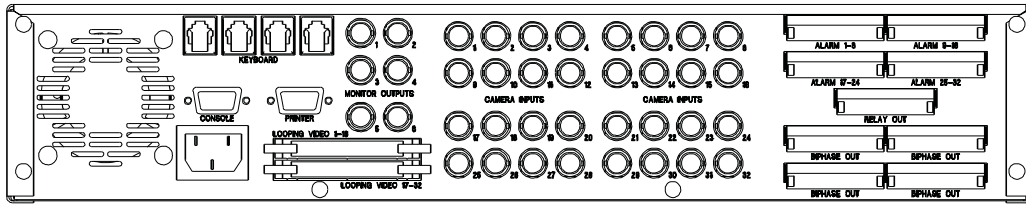

A1	Gnd	A2	A3	Gnd	A4	A5	Gnd	A6	A7	Gnd	A8
A9	Gnd	A10	A11	Gnd	A12	A13	Gnd	A14	A15	Gnd	A16
A17	Gnd	A18	A19	Gnd	A20	A21	Gnd	A22	A24	Gnd	A24
A25	Gnd	A26	A27	Gnd	A28	A29	Gnd	A30	A31	Gnd	A32

Rear Panel and Alarm Input Connector Detail

+	S	--	+	S	--	+	S	--	+	S	--
---	---	----	---	---	----	---	---	----	---	---	----

Rear Panel Biphase Outputs Connector Detail

R1	R1	R2	R2	R3	R3	R4	R4	R5	R5	R6	R6
----	----	----	----	----	----	----	----	----	----	----	----

Rear Panel Relay Outputs Connector Detail

Figure 7 LTC 8300 Series Rear Panel

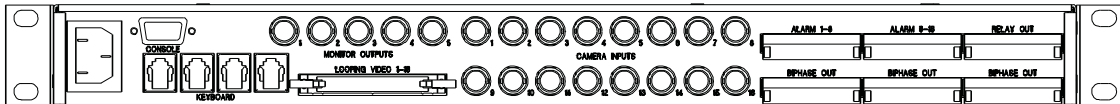

A1	Gnd	A2	A3	Gnd	A4	A5	Gnd	A6	A7	Gnd	A8
A9	Gnd	A10	A11	Gnd	A12	A13	Gnd	A14	A15	Gnd	A16

Rear Panel and Alarm Input Connector Detail

+	S	--	+	S	--	+	S	--	+	S	--
---	---	----	---	---	----	---	---	----	---	---	----

Rear Panel Biphase Outputs Connector Detail

R1	R1	R2	R2	R3	R3	R4	R4	R5	R5
----	----	----	----	----	----	----	----	----	----

Rear Panel Relay Outputs Connector Detail

Figure 8 LTC 8200 Series Rear Panel

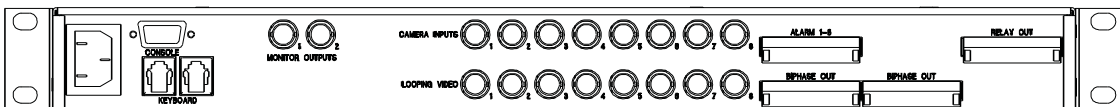

A1	Gnd	A2	A3	Gnd	A4	A5	Gnd	A6	A7	Gnd	A8
----	-----	----	----	-----	----	----	-----	----	----	-----	----

Rear Panel and Alarm Input Connector Detail

+	S	--	+	S	--	+	S	--	+	S	--
---	---	----	---	---	----	---	---	----	---	---	----

Rear Panel Biphase Outputs Connector Detail

R1	R1	R2	R2
----	----	----	----

Rear Panel Relay Outputs Connector Detail

Figure 9 LTC 8100 Series Rear Panel



Figure 10 LTC 8808/00 Video Interconnect Panel

## 7.0 OPTIONAL ACCESSORIES

### 7.1 Logging Printer Option Installation

NOTE: Installation for each printer varies; the following steps are generally required. Save the printer reference manual for procedures not covered.

- Switch the main power to the printer OFF.
- Install ribbon cartridge and paper if necessary.
- Set any configuration switches for your particular printer to match the format provided by the LTC 8300 Series system.
- The system communication protocol can be changed via keyboard **User Function 31** (see *Section 13, KEYBOARD USER FUNCTIONS*), the optional LTC 8059/00 MCS for Windows or the LTC 8850/00 GUI software. Factory default values are as follows:

Baud rate	19,200
Stop bits	1
Data bits	8
Parity	None

- The required interconnect cable uses a custom pinout. Refer to *APPENDIX D* for wiring details.
  1. Attach the 25-pin male D-type connector side of the RS-232 cable to the connector on the printer.
  2. Attach the 9-pin male connector side of the cable to the LTC 8300 Series bay connector marked **PRINTER**.
- Apply power to the printer.
- Verify printer logging by loading a previously stored sequence into a monitor, activating an alarm, or performing a system reset. Any of these actions should cause printouts to occur.

### 7.2 Windows-compatible Computer Interface Installation

NOTE: Installation for each computer varies; the following steps are generally required. Save the computer reference manual for procedures not covered here.

- Switch the main power to the computer OFF.
- Attach the PC security key, provided with the MCS for Windows or the LTC 8850/00 GUI software kit, to the computer.
- The supplied interconnect cable uses a custom pinout. If it ever becomes necessary to replace the cable, it can be ordered separately (part number: LTC 8506/00). Alternatively, a cable can be configured using the information in *APPENDIX D*.
  1. Attach one end of the supplied interface cable to the Allegiant bay connector marked **CONSOLE**.
  2. Attach the other end of the cable to an available serial port (COM1 or COM2) on the rear of the computer.
- Apply power to the computer and allow it to boot up its operating system before inserting the MCS or GUI software disc.
- Refer to the LTC 8059/00 MCS or LTC 8850/00 GUI software reference manual for operating instructions.

## 8.0 VIDEO MONITOR DISPLAY

The LTC 8100, LTC 8200, and LTC 8300 systems feature an integral text overlay with two rows of 24 characters each. There are a total of 235 different characters that can be displayed. Refer to *Section CHARACTER ROM TABLES* for further details.

NOTE: If no video signal is present, a third line will appear stating: VIDEO NOT PRESENT.

The display is broken down into five areas as shown in the *Figure 11* below:

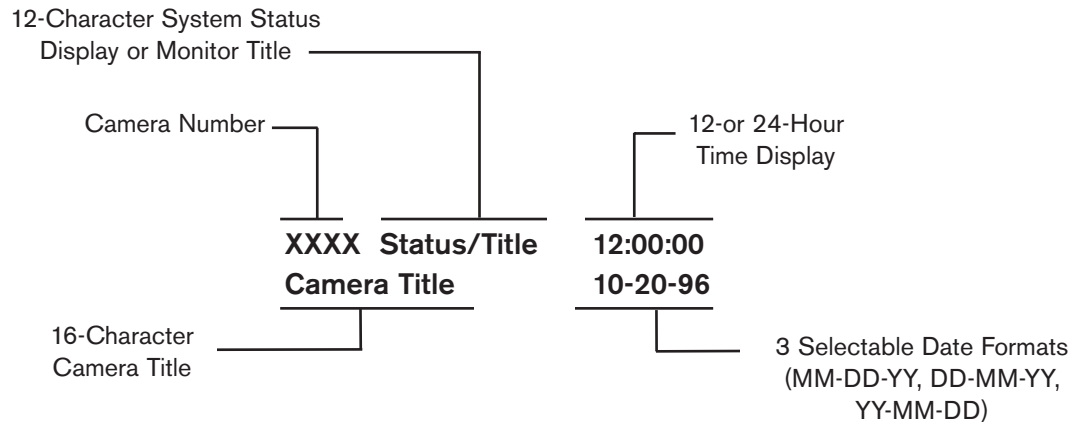

Figure 11 Monitor Overlay Display

## 8.1 Time / Date

The time/date display is generated by the system CPU microprocessor module. It is crystal controlled and battery protected for one year (minimum) without power. The display is updated once per second and all monitors update simultaneously. The time/date message is always on the right side of the video display with the time on the top line. Time displays hours, minutes, and seconds, and can be set to either 12-hour or 24-hour operation. The date is available in three user-selectable formats:

1. U.S. Format: **MM/DD/YY**
2. International Format: **DD/MM/YY**
3. Asian Format: **YY/MM/DD**

## 8.2 Monitor Title/System Status Display

The monitor title/system status display area is a 12-column display to the right of the camera number. It is unique on each of the monitors and has different uses, some of which may be user selected via keyboard. The various uses are described below.

### Format of Monitor Overlay's System Status Display

1	2	3	4	5	6	7	8	9	10	11	12
A	A	A	M	C	E	R	M	A	S	S	S
l	l	l	o	a	r	e	o	b	e	e	e
a	a	a	n	m	r	m	n	s	q	q	q
r	r	r			o			/			
m	m	m	A	A	r	L	L	R	N	N	S
			r	r	/	o	o	e	u	u	t
			m	m	D	c	c	l	m	m	a
					l	k	k				t
					R						

### 8.2.1 System Status Display

If this display is enabled (factory default), it allows the Allegiant system to dynamically inform the user of system status. The 12-column display is divided into smaller message columns (see *Figure above*), in which special characters report the following:

- Whether the switcher is running or stopped.
- The switcher's direction.
- Whether a monitor or remote camera is locked.
- The alarm status of the camera and monitor.

### 8.2.2 Locations 1, 2, and 3 - Alarm Indication

When the monitor overlay is in **Status Display** mode, locations 1 through 3 indicate whether a camera on the monitor is in alarm. If the on-screen camera is currently in alarm, an **ALM** message in a box will flash at this location. A **★★** in a box means that a camera other than the on-screen camera is in alarm. If no cameras are currently in alarm on this monitor, these spaces are blank. When a monitor has cameras in alarm, press **NEXT**, **RUN**, or **PREVIOUS** on the keyboard to move through the alarm sequencer rather than the regular camera sequencer. The alarm switcher status will be displayed in location 6 using symbols described.

### 8.2.3 Location 4 - Monitor Arm Status Indication

In the MONITOR ARMED location, the characters  $S_M$  or  $D_M$  will appear if the monitor is armed for alarm.  $S_M$  means that the monitor is a **step** or **sequence** monitor, and will automatically step through multiple alarm videos.  $D_M$  indicates that the monitor is a **display** or **review** monitor, which will collect alarm videos from one or more step monitors.

When an alarm occurs, the alarmed camera's video will replace the current display of the monitor. If the monitor is not armed, this location is blank.

### 8.2.4 Location 5 - Camera Arm Status Indication

In the CAMERA ARMED location characters  $C_A$  are displayed if the camera being viewed is armed for alarm on that monitor. If the alarm signal associated with this camera becomes active, the camera will be displayed on the appropriate armed monitors.

### 8.2.5 Location 6 - Error Indication

This location displays ERR when a user error occurs. The specific error number appears in locations 7 and 8, and also in the **Camera Number Display** field on the keyboard. The display will return to normal after a few seconds, or if the user presses **[Enter]** on the keyboard.

Location 6 is also used to indicate the sequencing direction when alarms occur. Possible character combinations are:

1.  $\wedge_R$ : the alarms are sequencing in a forward direction.
2.  $R_V$ : the alarms are sequencing in a reverse direction.
3.  $\wedge_S$ : the alarm sequencing has stopped, but if started again would sequence in a forward direction.
4.  $S_V$ : the alarm sequencing has stopped, but if started again would sequence in a reverse direction.

Location 6 can also be used to display a symbol indicating pan/tilt/zoom-equipped cameras. Using the optional LTC 8850/00 GUI software, controllable cameras can be individually configured to display a  $\triangleleft$   $\triangleright$  symbol in location 6 whenever they are viewed on a system monitor.



### 8.2.6 Location 7 - Remote Lock Indication

This location will display characters  $R_L$  to indicate that control over the movements of the camera being viewed have been **locked** by a user. Control over this camera is now possible only by the user who locked the camera, or has higher priority. If the camera is not locked, the icon is not displayed. If a user error has occurred, this location will temporarily hold part of the error number.

### 8.2.7 Location 8 - Monitor Lock Indication

This location will display characters  $M_L$  to indicate that the monitor has been **locked** by a user. The camera currently being viewed cannot be changed except by the user who locked the monitor, or has higher priority. If the monitor is not locked, the icon will not be displayed. If a user error has occurred, this location will temporarily hold part of the error number.

### 8.2.8 Location 9 - Sequence Type Indication

This location displays the type of sequence currently loaded on the monitor. An **absolute sequence** is indicated by the characters  $A_S$ , meaning that monitors programmed in the sequence program refer to the exact monitor(s) where the sequence may be run. Sequences created via the system keyboards are always of this type, so absolute sequences are the only type possible in a base system. **Relative sequences** are designated by the characters  $R_S$  in this location. These sequences will run on any monitor or group of monitors, and can only be programmed via the optional LTC 8059/00 MCS for Windows or the LTC 8850/00 GUI software on a PC.

### 8.2.9 Locations 10 and 11 - Sequence Number

The sequence number currently active for the monitor is displayed here. This is a number between 1 and 60, or 00 to indicate that no sequence is loaded.

### 8.2.10 Location 12 - Sequence Status Indication

This location indicates the status of the sequence active in the monitor. Possible character combinations are:

1.  $^R$ : the current sequence is sequencing in a forward direction.
2.  $R_V$ : the current sequence is sequencing in a reverse direction.
3.  $^S$ : the sequence is stopped, but if started again would sequence in a forward direction.
4.  $S_V$ : the sequence is stopped, but if started again would sequence in a reverse direction.

## 8.3 Monitor Message

The monitor message is a stationary 12-character title which may be placed on a monitor instead of the **System Status** display. Specific monitor messages can be programmed from either the keyboard (see **User Function 17** in *Section 13*) or the optional LTC 8059 MCS package or the LTC 8850/00 GUI software.

## 8.4 Broadcast Message

A message can be sent by the operator of the PC using the optional LTC 8059 MCS package or the LTC 8850/00 GUI software to all the monitors in the system. This message may be up to 24 characters, and can be used to notify all users at all monitor locations of important information. The message, along with its beginning and ending time and date, is also printed on the logging printer (if one is connected), as well as any user acknowledgment. The broadcast duration may be set for 1 to 60 seconds. The message is displayed on a line by itself.

## 8.5 Program Prompts

During entry of sequence programming via the keyboard, the Allegiant system prompts the user on the monitor his keyboard is currently controlling. The display will return to its previous form when the user leaves the **programming** mode.

## 8.6 Camera Number

The left-most display on the top line shows the system-generated camera number is always displayed. This unique number identifies this camera when using the keyboard for video call ups. In base systems, this number is the same as the numbered BNC connector that the camera is plugged into on the rear of the bay (physical camera number). However, the optional MCS for Windows or the optional GUI software package can be used to change this number to any unique number between 1 and 9999.

## 8.7 Camera Title

The camera identification display, which is the first 16 characters of the lower line, are used to label each camera. Each camera has its own title, displayed whenever that camera is called up for viewing. The 235 possible characters can be entered from the keyboard via user function, or from PC keyboard via the optional MCS for Windows or optional GUI software.

## 8.8 Video Loss Detection

The Allegiant system is capable of detecting loss of video. When the unit detects that an input has lost video, a VIDEO NOT PRESENT message is displayed on the respective monitor.

NOTE: It may take up to five seconds for the unit to display the video loss message when a video source is disconnected.

## 9.0 FACTORY DEFAULT SETTINGS

As the Allegiant system is shipped from the factory, certain features are set to a default configuration. Some features can be selected by the installer at the time of system installation/configuration. The default configuration represents the simplest mode of operation. Default settings are detailed in this section.

## 9.1 User Selectable DIP Switch Settings for System Configuration Options

NOTE: To access the DIP switches, refer to *Section 6* for cover removal instructions.

The circuit board contains two 8-position DIP switches (S0201 and S0202). The options assigned to DIP switches are:

Switch Number	Default Setting	Switch Function
S0201-1	OFF (NTSC)	Raster Frequency
S0201-2 to 8	OFF	Reserved
S0202-1 to 3	OFF	Reserved
S0202-4	OFF	Printer Port Mode
S0202-5	ON	Security Feature
S0202-6	OFF	Reserved
S0202-7	ON	Keyboard Mode
S0202-8	ON	Communication Parameters and Boot Screen Execution

### Switch 1 of S0201

This switch determines the frequency of an internal raster generator that is displayed on monitor outputs when a camera loses video or an unused channel is selected. The presence of the raster generator allows on-screen text to remain visible and includes a message notifying the user of the video loss condition.

**Factory Default Settings** for 60 Hz NTSC models is OFF, and ON for 50 Hz PAL models.

### Switch 2 to 8 of S0201

These switch functions are reserved and should be left OFF.

### Switch 1 to 3 of S0202

These switch functions are reserved and should be left OFF.

### Switch 4 of S0202

If switch 4 is ON (usually at system installation), the Printer port on the rear panel is configured as an auxiliary Console port. The Printer port has the same pin-out as the normal Console port, so the Console cable supplied with the LTC 8059/00 MCS for Windows or LTC 8850/00 GUI software may be used to interface with the Printer port when switch 4 is ON.

NOTE: This feature can also be implemented via the **PRT2CON** CCL command using an external PC, dumb terminal, or other computing device.

Communication parameters (baud & handshake) for the Printer port can be set via Keyboard **User Function 31** (covered later in this manual), with the optional LTC 8059/00 MCS for Windows, or the LTC 8850/00 GUI software.

#### Switch 5 of S0202

Switch 5 controls the system security modes. When this switch is ON (factory default), the system login features can be controlled using Keyboard **User Function 27** and **User Function 28** (see *Section 13, KEYBOARD USER FUNCTIONS*). Users with priority 1 can access **User Function 27** to enable or disable the system keyboard login feature. When enabled, the system keyboards require each user to logon and logoff the system. All users are required to enter a user number and the correct password before system interaction is permitted.

Users with priority 1 can also access **User Function 28** to enable or disable the Console port login feature. When enabled, any external PC or other computing device will be required to logon and logoff the system, and enter a user number and correct password. If this switch is OFF (usually at time of system installation) or if features are disabled via **User Function 27** and **28**, the system keyboards and the Console port are always online with the system.

#### Switch 6 of S0202

This switch is reserved, and should be left off.

#### Switch 7 of S0202

Switch 7 controls the system keyboard polling mode. When switch 7 is ON (factory default), the CPU communicates with system keyboards via a **6 poll byte** protocol. This format provides variable speed pan/tilt control for AutoDome-equipped camera sites.

NOTE: The variable speed mode is not compatible with the pre-1996 LTC 8561 Receiver/Drivers without using a LTC 8785 Series Code Converter unit.

Dip switch 7 can be turned off (usually at system installation) to allow operation with the older **fixed speed only** type keyboards that use a **4 poll byte** protocol. In this mode, the system can communicate with the older LTC 8561 Series of Receiver/Drivers, without using the LTC 8785 Code Converter unit. Note that **fixed speed** keyboard mode allows only the first 63 auxiliary and pre-position functions to be accessed. This is not an issue on older receiver/driver versions, but may pose a problem if the system must be expected to access all functions available in the AutoDome Series of pan/tilt/zoom dome cameras.

#### Switch 8 of S0202

Switch 8 controls the **Protocol Settings** of the Console and Printer external RS-232 ports.

If the switch is OFF, the system will use the **Factory Default Settings** for the RS-232 data communication protocols listed below.

With switch 8 ON, any RS-232 port protocols changed using keyboard **User Function 30** (covered later in this manual), the optional LTC 8059 MCS, or the optional LTC 8850/00 GUI software are active.

Users with priority level 1 can also use Keyboard **User Function 29** to reset any changed protocols back to the default settings (see below).

Switch 8 also controls the activation of a **boot screen** program previously downloaded into CPU memory. This custom program is entered via the optional LTC 8059 MCS, or the optional LTC 8850/00 GUI software, to provide special system functions/features. If the Switch is OFF, any existing boot screen will not be active.

If Dip switch 8 is OFF (or after activation of keyboard **User Function 29**), **Data Communication Settings** for the Allegiant systems:

Setting	Console Port	Printer Port
Baud	19,200	19,200
Stop Bits	1	1
Data Bits	8	8
Parity	None	None
Handshake	Yes	No

## 10.0 USER INFORMATION

There are eight levels of user priority in the system. Each of the 32 users in the Allegiant system has a default priority level assigned. User levels determine access to system functions and provide prioritization of user control of monitors and pan/tilt/zoom-equipped camera sites. Users with higher priority (highest = 1) can regain control over monitors or pan/tilt/zoom cameras **locked** by another user.

User Number	Default Password	Priority Level	Default Keyboard
1	1	1	1
2	2	2	2
3	3	2	3*
4	4	2	4*
5	5	8	—
6	6	8	—
7	7	8	—
8	8	2	—
9	9	2	—
10	10	2	—
11	11	2	—
12	12	2	—
13	13	2	—
14	14	2	—
15	15	2	—
16	16	2	—
17	17	2	—
18	18	2	—
19	19	2	—
20	20	2	—
21	21	8	—
22	22	8	—
23	23	8	—
24	24	8	—
25	25	8	—
26	26	8	—
27	27	8	—
28	28	8	—
29	29	8	—
30	30	8	—
31	31	8	—
32	32	8	—

\*Not applicable to LTC 8100 Series.

The 8 priority level user assignments can be changed via the optional LTC 8059/00 MCS for Windows or the LTC 8850/00 GUI software. For a base system, the above TABLE shows the default values set. Note that in base systems where the login feature has not been selected, user number is automatically assigned to a specific keyboard port. This essentially sets the keyboard as the priority determinator. Also shown in the TABLE are factory default user passwords. Once a user is logged on to the system, the password can be changed via keyboard **User Function 10**. Refer to *Section 13, KEYBOARD USER FUNCTIONS*.

### 10.1 User Priority Access Table

The following TABLE shows system function access as it applies to the 8 levels of users.

System Function	Priority Level		
	1	2 to 7	8
Switch Video On Monitors	Yes	Yes	Yes
Control Pan/Tilt/Zoom Camera	Yes	Yes	Yes
Lock Monitor	Yes	Yes	Yes
Lock Pan/Tilt/Zoom Camera	Yes	Yes	Yes
Acknowledge Alarms	Yes	Yes	Yes
Perform Keyboard Test	Yes	Yes	Yes
Show Keyboard Number	Yes	Yes	Yes
Activate Keyboard Beeper	Yes	Yes	Yes
Change User Password	Yes	Yes	Yes
Program Sequences	Yes	Yes	No
Position Video Overlay Display	Yes	Yes	No
Set Overlay Display Brightness	Yes	Yes	No
Select Overlay Display Type	Yes	Yes	No
Set System Time/Date	Yes	Yes	No
Program Pre-positions	Yes	Yes	No
Set Time/Date Format	Yes	No	No
Set Camera and Monitor Titles	Yes	No	No
Enable Time Events	Yes	No	No
Reset System	Yes	No	No
Printout Tables and Sequences	Yes	No	No
Default Monitor Overlay	Yes	No	No
Select Alarm Response Mode	Yes	No	No
Select Printer Mode	Yes	No	No
Designate Alarm Monitor Type	Yes	No	No
Select Keyboard LogIn	Yes	No	No
Select Console LogIn	Yes	No	No
Configure/Reset RS-232 Ports	Yes	No	No

## 11.0 ALARM INFORMATION

Automatically switching video in response to an external signal (usually a contact closure) is necessary in any video switching system. The Allegiant system permits users with priority level 1 to select 1 of 3 predefined alarm response modes (via keyboard **User Function 19**). A description of the three modes appear below. Pictorial examples of alarm responses are shown on the following pages.

The system can also be programmed with a variety of alarm response characteristics using the flexible VersAlarm system. See the LTC 8059/00 MCS for Windows or the LTC 8850/00 GUI software manual for details.

### 11.1 Basic Alarm Response Mode

In **BASIC** alarm response mode, any/all monitors can be selected as alarm display monitors. Each alarm can then be armed to display its camera(s) on any set of armed monitors. Multiple alarms, on the same monitor, sequence at a 1 second rate. Monitors and alarms can be armed and disarmed individually as required. Alarmed video automatically clears when the alarm input signal is reset.

### 11.2 Auto-Build Alarm Response Mode

This mode uses a set of (or all) monitors as alarm display monitors. Each triggered alarm displays its alarm video on a different monitor, starting with the lowest numbered armed monitor. If all armed monitors are already displaying alarm video, subsequent alarms will build on the existing alarmed monitors. Each monitor sequences through its alarm videos at a 1 second rate. Monitors and alarms can be armed and disarmed individually, as required. Alarmed video automatically clears when the alarm input signal is reset.

### 11.3 Sequence & Display Alarm Response Mode

This mode designates two monitors as alarm response monitors. Monitor #1 is the **DISPLAY** monitor (also called a **REVIEW** monitor) and monitor #2 is the **SEQUENCE** (or **STEP**) monitor. The first alarm will appear on both monitors; additional alarms will begin to sequence at a 1 second rate on the **SEQUENCE** monitor. The **DISPLAY** monitor holds the first alarmed camera video until manually acknowledged via the keyboard. When the first video is cleared from the **DISPLAY** monitor, the next alarmed video (**next** is the camera that alarmed second) is displayed until cleared. Operation continues in this manner. Alarms can be armed and disarmed individually, as required. All alarms must be manually cleared; the presence of alarm video is not dependent upon the duration of the alarm input signal to the system.

### 11.4 Alarm Activated Pre-Position

Alarm activated pre-position enables a pan/tilt/zoom-equipped camera to automatically position itself to a preprogrammed scene as a result of an alarm signal. This capability exists in each of the three alarm response modes. The pan/tilt and zoom on the camera must have the necessary options for pre-position control. The system default is to activate pre-position #16 of the system camera receiving an alarm. Use the optional MCS for Windows package or the LTC 8850/00 GUI software, to configure the response to alarms as required by the user.

## 11.5 Sample Alarm Responses

### 11.5.1 Basic Mode

In **Basic** alarm response mode, cameras are individually armed for each alarm monitor.

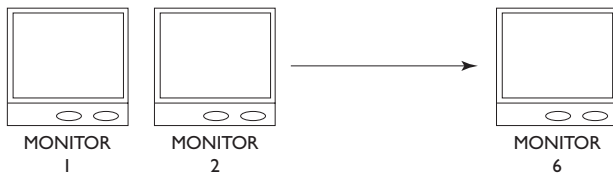

#### Alarm Status

1st Alarm

2nd Alarm

3rd Alarm

#### Alarm Station Display

Video associated with 1st alarm is displayed on any/all appropriately armed monitors.

Video associated with 2nd alarm is displayed on any/all appropriately armed monitors.

Video associated with 3rd alarm is displayed on any/all appropriately armed monitors.

Monitors and their respectively armed cameras are programmed individually.

Multiple alarms on monitors are sequenced automatically.

Alarmed video remains on monitors for duration of alarm input signal.

### 11.5.2 Auto-build Mode

In the **Auto-build** alarm response mode, alarms **build up** on armed monitors as new alarms are received.

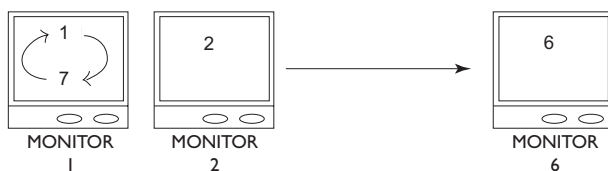

#### Alarm Status

1st Alarm

2nd Alarm

3rd Alarm

6th Alarm

7th Alarm

#### Alarm Station Display

Video associated with 1st alarm is displayed on monitor # 1 (if armed).

Video associated with 2nd alarm is displayed on monitor # 2 (if armed).

Video associated with 3rd alarm is displayed on monitor # 3 (if armed).

(Continue sequence)



Video associated with 6th alarm is displayed on monitor # 6 (if armed).

Video associated with 7th alarm is sequenced with video of 1st alarm on monitor # 1.

Any number of monitors may be armed.

Multiple alarms on monitors are sequenced automatically.

Alarm video remains on monitors for duration of alarm input signal.



### 11.5.3 Sequence & Display Mode

In the **Sequence & Display** mode alarm response mode, a monitor pair is used to display alarmed video.

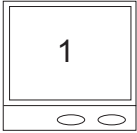
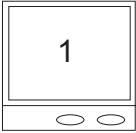
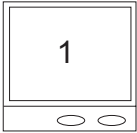
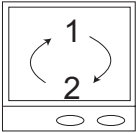
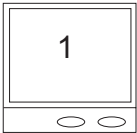
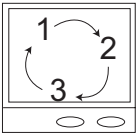
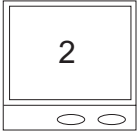
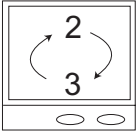
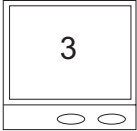
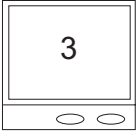
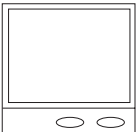
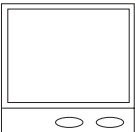
	Display Monitor	Sequence Monitor	Keyboard Operator Monitor Actions	Action
1st Alarm Occurs			D = Video associated with 1st alarm is displayed. S = Video associated with 1st alarm is displayed.	NONE
2nd Alarm Occurs			D = Video associated with 1st alarm is still displayed. S = Video associated with 1st and 2nd alarms are sequenced.	NONE
3rd Alarm Occurs			D = Video associated with 1st alarm is still displayed. S = Video associated with 1st, 2nd, and 3rd alarms are sequenced.	NONE
			D = 1st alarm video is removed. 2nd alarm video is now displayed. S = Video associated with 2nd and 3rd alarms continue to sequence.	1st ALARM IS ACKNOWLEDGED
			D = 2nd alarm video is removed. 3rd alarm video is now displayed. S = Only video associated with 2nd alarm remains.	2nd ALARM IS ACKNOWLEDGED
			Since all alarms have been acknowledged, both monitors return to normal operator control.	3rd ALARM IS ACKNOWLEDGED

## 12.0 KEYBOARD OPERATION

### 12.1 General

Primary operation of an Allegiant switcher is controlled via system keyboard. The 2 types of keyboards currently available are:

- Conventional LTC 8555 Series (incorporates LEDs and pushbuttons)
- IntuiKey model (uses dynamic LCD menu screens)

General operation steps for both keyboard models follows. Refer to the individual instruction manuals supplied with the keyboard for additional information.

As the system is supplied from the factory, various user-selectable features have been set to a default state. See *Section 9, FACTORY DEFAULT SETTINGS* for feature descriptions. Since these features are user selectable and can have a significant effect on the operation of the system, it is important to take note of any changes that may be in effect.

## 12.2 System Commands

### 12.2.1 Keyboard Login Procedure

Keyboard modes:

- Via **Factory Default Settings**, a keyboard is ready for use as soon as power is applied to the system.
- System operator must logon to a keyboard to access the system. When a system is configured to use the keyboard logon, operators must be pre-assigned a user number and password. Up to 32 user numbers are available, each having default priority level. User specific priority levels can only be changed via the optional PC-based MCS program. Refer to the MCS manual for complete details.

If the logon feature is enabled and an operator is not logged in, LED keyboards show flashing dashes in their display. IntuiKey keyboards prompt for entry of a user number when attempting to enter the main Allegiant softscreen menu.

Enter your assigned user number via the numeric keypad and press **[Enter]**. When prompted, enter the password. Invalid passwords cause the keyboard to revert to its initial state. Once the login is successful, the keyboard will show camera and monitor numbers in its display.

Upon logging in, the monitor controlled by the keyboard may automatically switch to a pre-assigned camera number. This function is only applicable if enabled by the system administrator (via the optional MCS package) and may not function if the monitor is running a sequence and/or in an alarm condition.

**NOTE: The information below applies to both IntuiKey keyboards and LTC 8555 Series keyboards. Where applicable, button designations specific to IntuiKey keyboards will be shown in plain text. Equivalent button designations that apply to LTC 8555 Series keyboards will be placed in [ ] immediately after the IntuiKey button text.**

### 12.2.2 Keyboard Logoff Procedure

If the login feature has not been enabled, this action is not applicable. If the feature has been enabled, press **User Logoff [User, then OFF]**.

## 12.3 Switcher Commands

### 12.3.1 Camera Selection

The keyboard default mode is the camera mode, so enter a camera number for viewing, and press **[Enter]**.

### 12.3.2 Monitor Selection

Press **MON [Monitor]**, enter a monitor number, and press **[Enter]**.

## 12.4 Controlling Camera Movement

### 12.4.1 General

Camera positioning is controlled via an eight-way joystick on the right-hand side of the keyboard. This joystick moves the camera pan/tilt, (if equipped), up, down, left, right, or diagonally. Rotate the joystick knob to control the zoom lens in or out.

Moving the joystick up and to the right simultaneously moves the camera in a diagonal direction. Rotating the ZOOM control knob causes the lens to either zoom in or out. The direction of its response depends on the camera/lens model, and certain system configuration settings that are determined at installation.

Up to four pan/tilt/zoom commands may be sent to a remote camera site at a time (Example - Zoom In, Focus Far, Pan Left, and Tilt Down). All three zoom lens functions can also be sent simultaneously (Example - Zoom Out, Focus Near, Iris Open).

#### 12.4.2 Focus and Iris Lens Control

The lens control buttons are on the right side of the keyboard. The camera's zoom lens, (if equipped), can be controlled to focus near or far, and open or close the iris (if the lens supports manual iris operation).

#### 12.4.3 Lock or Unlock Control of a Camera

When using IntuiKey keyboards, press **Device Lockout**, located on the main **Allegiant** menu screen to enter a menu screen for these options.

With LTC 8555 Series keyboards, press [**Lock**], then [**ON**] to lock a camera, or [**OFF**] to unlock a camera. If the camera to be locked is not the one currently being viewed, enter the camera number via the numeric keyboard (but do not press [**Enter**]) before pressing the [**Lock**].

If the **Status** option is enabled, the section of the on-screen overlay between the camera number and the time shows  $R_L$ , indicating the camera is locked. Activating a camera lock immediately prevents other operators (unless they have a higher priority) from controlling the locked pan/tilt/zoom camera. Remember to unlock the camera when finished so other operators can access it.

#### 12.4.4 Lock or Unlock Control of a Monitor

When using IntuiKey keyboards, press **Device Lockout**, located on the main **Allegiant** menu screen, to enter a menu screen with these options.

With LTC 8555 Series keyboards, press [**Monitor**], [**Lock**], then [**ON**] to lock a monitor, or [**OFF**] to unlock the monitor. If the monitor to be unlocked is not the one currently being controlled by the keyboard, enter the monitor number (but do not press [**Enter**]) after you press [**Monitor**].

If the **Status** option is enabled, the section of the on-screen overlay between the camera number and the time shows a  $M_L$  indicating the monitor is locked. This prevents other operators from changing the video on the monitor being used (unless they have a higher priority). Remember to unlock the monitor when finished so other operators can access it.

If an operator with a higher priority accesses a locked monitor and switches to a different camera, the lock is automatically removed.

#### 12.4.5 Recording a Camera Pre-position Scene

Select a camera with pan/tilt/zoom control with pre-position options. Using the joystick and lens controls, adjust the camera to view the scene you wish to store. When using IntuiKey keyboards, press **Camera Control**, located on the main **Allegiant** menu screen to enter a menu screen with this option. Press **Set Shot** [**Set**], then select the scene number via the numeric keypad, and press [**Enter**]. The camera position will now be stored for recall later.

If an AutoDome Series camera is being used, certain pre-position commands are also used to activate operational features/functions. Refer to the AutoDome operation manual for complete information. If an Allegiant conventional receiver/driver is being controlled, the pan/tilt and zoom lens must have the necessary options for pre-position operation.

On certain models of AutoDomes and Allegiant Receiver/Driver Series, it is possible to disable a previously stored pre-position, or remove it from a pre-position tour, by pressing **Set Shot** [**Set**], the digit 9, followed by the 2-digit pre-position number. Refer to information supplied with the device to determine whether it supports this feature.

### 12.4.6 Recalling a Camera Pre-position Scene

Select the camera to be activated. Press **Shot**, enter a previously stored camera position number via the numeric keypad, then press **[Enter]**. The camera automatically returns to the previously stored position. If a second pre-position is called prior to the completion of the first, the camera will move directly to the second shot. If the AutoDome Series camera is being used, certain pre-position commands are also used to activate operational features/functions. Refer to the AutoDome operation manual for complete information.

### 12.4.7 Activate/Deactivate Auxiliary Function

When using IntuiKey keyboards, press **Camera Control**, on the main **Allegiant** menu screen, to enter a menu containing this option. To turn on an **auxiliary** function of a remote camera device, press **Aux ON [ON]**, enter the number of the auxiliary you wish to activate, then press **[Enter]**. Holding the **[Enter]** key down causes the **auxiliary** function to be sent repeatedly. This capability is useful when the auxiliary is activating a housing window washer function, or a temporary light source.

To turn off an **auxiliary** function of a remote camera device, press **Aux OFF [OFF]**, enter the number of the auxiliary you wish to deactivate, then press **[Enter]**.

With the AutoDome Series of cameras, auxiliary commands are used to activate/deactivate certain operational features/functions. Refer to the AutoDome camera manual for complete information on features supported by the model.

In the Allegiant Receiver/Driver Series, the first 4 auxiliaries correspond to relay outputs. Option switches in the receiver/driver can configure these to operate as either **latching** or **momentary** type functions. If configured for the **latching** type, the auxiliary will stay on once activated, until turned off. If configured as **momentary**, the auxiliary remains on only as long as the **[Enter]** key is depressed. Auxiliary outputs 2 through 4 can also be configured as a contact closure, 24 VAC, or as line voltage. Auxiliary number 5 controls the **DITHER** function, detailed below. Auxiliary number 6 corresponds to an internal receiver/driver **AUTOPANNING** feature, previously enabled by an option switch inside the receiver/driver.

**DITHER** is a legacy Allegiant receiver/driver feature designed to extend the life of tube-based low-light level cameras. Its function was to prevent bright lights in the scene from burning a spot on the camera imager. When this feature is active, and the pan/tilt is not moved for a period of about 2 minutes, the receiver/driver automatically pans right for approximately 0.5 seconds. Two minutes later, a pan left occurs, and the cycle continues until disabled. The feature is enabled by an option switch in the receiver/driver, and is controlled by the **auxiliary 5** function. To activate the **DITHER** function, turn on **auxiliary 5**. To deactivate the feature, turn **OFF auxiliary 5**. When first enabled, the pan/tilt unit makes one short left/right cycle to indicate that the **DITHER** function has been activated. Note that a camera in the **DITHER** mode will accumulate a viewing error if left unattended for a long period of time, so occasionally a manual adjustment of the pan/tilt may be required.

## 12.5 Alarm Commands

### 12.5.1 Arm/Disarm Individual Alarms

Alarm commands control the system's automatic video switching capabilities, in response to alarm signals.

When using IntuiKey keyboards, press **Alarm Control**, located on the main Allegiant menu screen, to enter a menu screen with these options. To arm an individual alarm on the monitor currently controlled by the IntuiKey, press **Arm Alarm**, enter alarm number to be armed via the numeric keypad, and press **[Enter]**. To disarm an individual alarm when using the IntuiKey, press **Disarm Alarm**, enter the alarm number to be disarmed via the numeric keypad, and press **[Enter]**.

To arm/disarm an individual alarm when using LTC 8555 Series keyboards, press **Alarm**, enter in the alarm number to be armed via the numeric keypad, and press **[ON]** to arm the alarm, or **[OFF]** to disarm it.

Using default settings, the camera activated by an alarm is normally the same as the alarm number, although this relationship can be changed via the optional Allegiant PC-based MCS package. When the alarm number does not match the camera number, it is important to specify the alarm number when using this command.

The monitor status display (if enabled) shows  $C_A$  (camera/alarm armed) whenever an armed camera is selected.

### 12.5.2 Arm/Disarm All Alarms

Press **Alarm Control**, located on the main **Allegiant** menu screen to enter the menu screen containing these options.

When using the IntuiKey:

- To arm all alarms on the monitor currently controlled, press **Arm All Alarms**.
- To disarm all alarms, press **Disarm All Alarms**.

When using LTC 8555 Series keyboards:

- To arm all alarms, press **User, Alarm**, and then **[ON]**.
- To disarm all alarms, press **[OFF]**.

### 12.5.3 Arm/Disarm Monitor

When using IntuiKey keyboards:

- Press **Alarm Control**, located on the main **Allegiant** menu screen to enter the screen with these options.
- To arm the monitor currently controlled, press **Arm Monitor**.
- To disarm the monitor, press **Disarm Monitor**.

When using the LTC 8555 Series:

- To arm the monitor, press **User, Monitor**, then **[ON]** to arm all alarms.
- To disarm all alarms, press **[OFF]**.

NOTE: Alarm video will appear on a monitor only if the monitor is armed and the alarm is armed for that monitor. The monitor status display (if enabled) will show a  $M_A$  (monitor armed).

### 12.5.4 Alarms Acknowledgement

**Bell [Ack]** is provided so system operators can respond to alarms from the keyboard. Pressing **Bell [Ack]** while the keyboard is beeping (due to an alarm condition) always silences the beeper. Depending on alarm configuration programming, subsequent pressing of **Bell [Ack]** either clears alarm video from the monitors or has no effect.

## 12.6 Sequence Control

### 12.6.1 Load/Clear a Sequence

To load a previously programmed sequence to run on your monitor, press **Load Sequence [Seq]**, enter the desired sequence number (1 to 60), then press **[Enter]**. Note that loading a sequence does not automatically start the sequence running.

Since sequences may be programmed to use more than one monitor, all required monitors must be available. If a sequence is already on a monitor, the operator who loaded it originally (or an operator with a higher priority) is permitted to load a new sequence on the monitor(s). Others will receive an error message.

To clear a monitor sequence, press **Load sequence [Seq]**, then press **[Enter]**. Only the operator who originally loaded it (or an operator with a higher priority) is permitted to clear a monitor sequence. Others will receive an error message.

If enabled, the status display area of the monitor indicates the sequence number in the appropriate location. If no sequence is currently loaded, 00 is displayed.

### 12.6.2 Run a Sequence

To run a sequence currently loaded on a monitor, press **Start Sequence [Run]**. If the sequence was stopped, the command starts sequencing. Direction of the sequencing is indicated in the monitor status display (if enabled), by a directional arrow and the letter **R** to the right of the sequence number. If **Start Sequence [Run]** is pressed while a sequence is already running, the switcher goes immediately to the next step in the sequence. Holding down **Start Sequence [Run]** produces a **quick-scan** effect. If **Start Sequence [Run]** is depressed when no sequence is loaded, an error results. If the monitor is in alarm, **Start Sequence [Run]** controls switching of alarm video rather than a loaded sequence.

### 12.6.3 Stop a Running Sequence

To stop a sequence that is currently running, press **Hold Sequence [Hold]**. The monitor status display now shows a **S** to the right of the sequence number. If the sequence is already stopped, pressing **Hold Sequence [Hold]** has no effect. If no sequence is currently loaded, pressing **Hold Sequence [Hold]** results in an error condition. If the monitor is in alarm, **Hold Sequence [Hold]** stops the alarm switcher rather than a loaded sequence.

### 12.6.4 Controlling Sequence Direction

The direction of a sequence can be set to run either forward or reverse. It is also possible to manually step forward or reverse through a stopped sequence. These actions work as follows:

If **Next Sequence Step [Next]** is pressed with the sequence in the stop state, the sequence switches forward and remains stopped. If the sequence is running when **Next Sequence Step [Next]** is pressed, it immediately goes to the next step and continues to run. The same is true for the **Previous Sequence Step [Prev]** button, but in the reverse direction. If either **Next Sequence Step [Next]** or **Previous Sequence Step [Prev]** is held down, **quick-scan** switching at a rate of approximately two steps per second will take place. When sequences are first loaded, their direction defaults to forward.

If **Previous Sequence Step [Prev]** is pressed while a camera sequence is running, it reverses the sequence. If **Previous Sequence Step [Prev]** is pushed while in a **hold** mode, and the display is showing the forward prompt, the first push changes the direction only, and a second push then switches to the previous step. The same is true for **Next Sequence Step [Next]**, in the opposite direction. The monitor status display shows an arrow pointing either up or down to indicate the sequence direction. The arrow will be to the right of the sequence number, either above or below the sequence run **R** or stopped **S** indicator. If the monitor is in alarm, **Previous Sequence Step [Prev]** and **Next Sequence Step [Next]** control the alarm switcher rather than the loaded sequence.

If no sequence is loaded, pressing **Next Sequence Step [Next]** or **Previous Sequence Step [Prev]** automatically steps the switcher through the camera numbers in numerical order.

## 12.7 Sequence Programming

### 12.7.1 Programming a Simple Camera Sequence

The Allegiant system has very powerful sequencing capabilities. Using a system keyboard, it is possible to enter sequences to run on a single or on multiple monitors. As long as valid camera and monitor numbers are used, they can be entered into a sequence randomly. More powerful features are available when sequences are programmed via the PC-based LTC 8059 MCS, including receiver/driver activation as part of a sequence step.

Sequence programming is only limited by the amount of CPU memory reserved for storing the sequence steps. The current limit for these Allegiant models is 3000 steps.

Comparing a sequence to a spreadsheet, a simple sequence would consist of 3 columns as follows:

CAMERA	MONITOR	DWELL
1	1	2
2	1	2
3	1	2
4	1	2
5	1	2

Sequence programming is best described by going through the above example. To enter the **programming** mode, press **Program Sequence [Prog]**. Enter an available sequence number (1 to 60 for these Allegiant models), then press **[Enter]**. The on-screen monitor display changes to the following format:

```
1st Line = Camera (Ignore)   S0001   L0001 Time (Ignore)
2nd Line = >C0001<         M001     D02   Date (Ignore)
```

The top line of the display always indicates the current step being viewed in the *S0001 Section*. The total length of the sequence is displayed in the *L0001 Section*.

When programming a new sequence, the camera number that was being viewed before entering the **programming** mode is automatically placed between the **><** prompts, as in **C0001** above. Now enter the 1st camera of the sequence into this position. If the camera number is correct, no action is necessary. If not, enter the desired camera number via the keypad, and press **[Enter]**.



Using the joystick, move **RIGHT** one step. The prompts will shift over to the monitor number shown in the example as **M001**. The monitor that was being controlled by the keyboard before entering the **programming** mode is defaulted to this position. If correct, no action is necessary. If not, enter the desired monitor number via the keypad, and press **[Enter]**.

Move **RIGHT** again. The prompts now shift over to the dwell time shown in the example as **D02**. The default dwell time for a new sequence is always 2 seconds. If a different dwell period is desired, change the value to any number between 1 and 60. One line is now complete.

Press **Next Step [Next]** to add a second line. The camera number automatically increments, while the monitor number and dwell remain the same as the first line. Since this line is correct, no change is necessary and **Next Step [Next]** may be pressed 3 more times until line 5 is reached. The joystick can be used to move around within the spreadsheet, but only the **Next Step [Next]** key can add new lines.

Continue entering camera, monitor, and dwell times in this fashion, until finished.

If you only want to store the sequence for future use and then exit the **programming** mode, press **Exit / Save [Prog]**. Press **Exit / Run [Run]**, to exit the **programming** mode, store the sequence into memory, and start the sequence running. The switcher steps through the 5 steps in the order shown, and repeats the sequence when it reaches the last step. To program a sequence to run once through all its steps and then stop, enter the value **62** for the dwell time in the last step and press **[Enter]**. The dwell display will change to **STP**, meaning stop. To program a sequence to run once through all its steps and then unload itself, enter the value **63** for the dwell time in the last step, and press **[Enter]**. The dwell display will change to **ULD**, meaning unload.

To edit an existing sequence, press **Program Sequence [Prog]**, enter the existing sequence number, then press **[Enter]**. You can insert a line into a sequence by navigating down to the line where inserting a new line, and press **Insert Step [ON]**. A new line identical to the one you are on is added to the next step. To delete a step, navigate to the line to be deleted, and press **Delete Current Step [OFF]**. To delete all steps below the line you are viewing, press **Delete From Here To End [Lock]**. (Be careful with this feature!)

It is also possible to erase a sequence:

Press **Delete From Here To End [Lock]** while on the first line of the sequence. Then press **Delete Current Step [OFF]**. The sequence will be erased, and the **programming** mode is automatically exited.

### 12.7.2 Programming a SalvoSwitching Camera Sequence

A SalvoSwitching sequence can be used to switch a group of monitors simultaneously as a synchronized group. To program a Salvo sequence, enter the **programming** mode as described above for a simple camera sequence. By definition, Salvo sequencing involve more than one monitor. An example of a simple Salvo sequence that switches cameras on three monitors simultaneously is shown below:

CAMERA	MONITOR	DWELL
1	1	SLV
2	2	SLV
3	3	2
7	1	SLV
8	2	SLV
9	3	2
21	1	SLV
22	3	SLV
23	3	2

In general, follow the instructions used for the simple camera sequence (described above), but instead of entering a number of seconds for steps that must switch instantly, enter **61** and press **[Enter]**. This causes the switcher to automatically change to the salvo abbreviation **SLV**. Dwell time (in seconds) is entered only when you reach the step containing the last monitor that will be switched within the synchronized group.

## 13.0 KEYBOARD USER FUNCTIONS

### 13.1 General

User functions are keyboard operations which are used infrequently, but provide important system options. These functions are listed below.

**NOTE:** Certain functions are restricted to certain user priority levels. Information on user priority levels can be found in *Section 10, USER INFORMATION*. To execute these user functions, select the desired function, and follow the steps below.

For IntuiKey Keyboards:

1. From the main Allegiant screen, press **User Functions** (softkey).
2. Use **Previous** or **Next** to navigate to the desired function.
3. Press the desired softkey.

For LTC 8555 Series Keyboards:

1. Press **USER** and verify the indicator lights.
2. Using the numeric keypad, enter the desired user function number.
3. Press **[Enter]**. Note that the keyboard camera display shows **F** followed by the selected function number.
4. Follow the directions for the specific user function (described in its section, herein). In many cases, the joystick is used to select options
5. Press **USER** to exit back to **normal** mode.

#### **EXAMPLE: USER 2 ENTER**

The above example accesses **User Function #2** as described in **THIS SECTION**.

Fn#	Joystick Up/Down	Joystick Left/Right	Access Level Function Description	1	2-7	8
1	n/a	n/a	Local keyboard test	Y	Y	Y
2	n/a	n/a	Show keyboard port number	Y	Y	Y
3	n/a	n/a	Select keyboard beeper ON/OFF	Y	Y	Y
4	Up/Down	Left/Right	Adjust position of monitor display	Y	Y	N
5	Brightness	Msg vs. Stat	Monitor display brightness / status selection	Y	Y	N
6	Time/Date ON/OFF	Overlay ON/OFF	Select monitor display option	Y	Y	N
7	Set	Select	Set time	Y	Y	N
8	Set	Select	Set date	Y	Y	N
9	Set	Select	Set camera ID	Y	N	N
10	n/a	n/a	Change user password	Y	Y	Y
11	Select	n/a	Select time/date format	Y	N	N
12	n/a	n/a	Default all monitor overlays	Y	N	N
13	Select	n/a	Print configuration tables to system printer	Y	N	N
14	n/a	n/a	Reserved	—	—	—
15	n/a	n/a	Reset system (password required)	Y	N	N
16	Select	Enable/Disable	Time event enable/disable	Y	N	N
17	Set	Select	Set monitor ID	Y	N	N
18	Select	n/a	Print sequence	Y	N	N
19	Select	n/a	Select alarm response (password req'd)	Y	N	N
20	Select	n/a	Select printer verbosity	Y	N	N
21	Select	n/a	Designate alarm monitor type (password)	Y	N	N
22	Select	n/a	Select control code format (fixed/variable)	Y	N	N
23	n/a	n/a	Display CPU software version number	Y	Y	Y
24	Up/Down	Left/Right	Set positions on all monitor displays	Y	Y	N
25	Brightness	Msg vs. Stat	Set brightness on all monitor displays	Y	Y	N
26	Time/Date	Overlay	Set display option on all monitors	Y	Y	N
27	Keyboard Login	Select	Select keyboard login	Y	N	N
28	Console Login	Select	Select console login	Y	N	N
29	Default Parameters	Select	Default RS-232 parameters	Y	N	N
30	Console Parameters	Select	Set console RS-232 parameters	Y	N	N
31	Printer Parameters	Select	Set printer RS-232 parameters (LTC 8300 only)	Y	N	N
32	n/a	n/a	Reserved	—	—	—
33	n/a	n/a	Display user number and priority	Y	Y	Y
34	Select	n/a	Camera indicator	Y	N	N
35	Camera No.	Enable/Disable	Controllable cameras	Y	N	N
36	Select	Enable/Disable	Select crosspoint data	Y	N	N
37	Select	n/a	R/D addresses mode	Y	N	N
38	Select	n/a	Printer port mode	Y	N	N
39	Select	n/a	Select DIU interface port	Y	N	N
40	n/a	n/a	Vertical sync adjust	Y	N	N
41	Select	n/a	Cache remote Cameras	Y	N	N
42	Select	n/a	Keyboard login auto-off mode	Y	N	N
43	n/a	n/a	CPU battery status	Y	Y	Y
99	Select	n/a	Use functions index	Y	Y	Y

### 13.1.2 User Function 1 - Local Keyboard Test

**User Function 1** can be used as a local test to ensure that all the keyboard LEDs and switches are working. This function automatically calibrates the center position of the analog joystick on LTC 8555 keyboards. Upon entering this test, the keyboard will beep and all LEDs will light for about two seconds. The USER should note if there are any LED failures.

Each key may be pressed to display a unique code number associated with that key. Follow the TABLE below to ensure that all keys are properly being processed by the keyboard. Push **USER** last, as this causes the keyboard to exit the **test** mode.

If the logon system feature has been selected by the system installer, the same local test may be initiated while the keyboard is not **ON LINE** by pressing \*.

Key	No.	Key	No.
IRIS UP	044	CAMERA	024
IRIS DOWN	045	MONITOR	008
FOCUS UP	042	ACKNOWLEDGE	005
FOCUS DOWN	043	PROGRAM	002
ZOOM CLOCKWISE <sup>1</sup>	041	SET	001
ZOOM COUNTER <sup>1</sup>	040	SHOT	009
CLOCKWISE		OFF	025
ALARM	004	ON	017
USER	000	*	016
SEQUENCE	032	LOCK	003
HOLD	036	#7	012
RUN	033	#8	020
PREVIOUS	035	#9	028
NEXT	034	CLEAR	037
#1	010	#0	013
#2	018	ENTER <sup>1</sup>	029
#3	026	UP <sup>1</sup>	052
#4	011	RIGHT <sup>1</sup>	051
#5	019	DOWN <sup>1</sup>	050
#6	027	LEFT <sup>1</sup>	053

<sup>1</sup>Keyboard tests show a speed indicator value in the first digit position when performing pan, tilt, or zoom actions.

### 13.1.3 User Function 2 - Show Keyboard Port Number

**User Function 2** may be used to identify which port a keyboard is plugged into. After entering **User Function 2**, read the keyboard port number from the monitor display on the keyboard. If using the LTC 8555 Series keyboard, press [**User**] to exit.

### 13.1.4 User Function 3 - Select Keyboard Beeper ON/OFF

When **User Function 3** is selected, the keyboard user may enable/disable the keyboard audio beeper. If using the LTC 8555 Series keyboard, press [**ON**] to enable the beeper or [**OFF**] to disable it. Press [**User**] to exit. Upon power up of the keyboard and whenever the Allegiant system undergoes a reset, this setting is set to [**ON**].

### 13.1.5 User Function 4 - Adjust Position of Monitor Overlay

**User Function 4** allows the characters on the video monitor display to be positioned from the keyboard. Only the display on the monitor that the keyboard is currently connected to is effected.

If using the LTC 8555 Series keyboard, use the joystick to position the display as required. Press [**Enter**] to store the position. Press [**User**] to exit.

### 13.1.6 User Function 5 - Monitor Display Brightness / Status Selection

The white portion of the characters on the video monitor display may be made brighter or dimmer by the **User Function 5**. Only the display on the monitor that the keyboard is currently connected to is effected. After entering the mode, there are four possible settings. If using the LTC 8555 Series keyboard, moving the joystick up increases the brightness, and moving it down decreases the brightness.

The **User Function 5** also permits selection of either the **status** display or a 12-character **monitor message** to appear in the first line of the monitor display. The **status** display indicates alarm, sequence, and lockout information regarding the monitor. The **monitor message** is a stationary display. This means the display will not change as video is switched from camera to camera on the monitor. After entering the mode, move the joystick left to select **monitor message** format, and right to select **status** format. If using LTC 8555 Series keyboard, to exit the mode, press [**User**].

### 13.1.7 User Function 6 -

#### Select Monitor Display Option

**User Function 6** allows the user to remove the time and date (the left side of the display), or the entire display from the individual monitor. If using the LTC 8555 Series keyboard, move the joystick down to blank the time and date from the screen. This is sometimes desirable when a VCR with its own time and date is being used. Move the joystick up to add the time and date back.

Move the joystick left to blank the left side portion of the display from the monitor, and right to return it. Refer to **User Function 5** to verify brightness level. Press **[User]** to exit the mode.

### 13.1.8 User Function 7 -

#### Set Time

**User Function 7** enables operator setting of the time displayed on all system monitors. After entering the mode, use the joystick select hours, minutes, or seconds in an edit line (displayed on the monitor screen). If using the LTC 8555 Series keyboard, moving the joystick up or down counts the data item up or down; moving right or left selects between data items. **NEXT** is used to set the seconds to zero. If **NEXT** is pressed when the seconds are over 30, the minute count (shown on the operating clock display) is incremented. If **NEXT** is pressed when the seconds are under 30, the minutes are left unaffected. Press **[Enter]** to update the time displayed on all system monitors, and press **[User]** to exit the mode.

### 13.1.9 User Function 8 -

#### Set Date

**User Function 8** enables the operator to set the date displayed on all system monitors. If using the LTC 8555 Series keyboard, the joystick is used to select the day, month, or year in an edit line (displayed on the monitor screen). Move the joystick up or down to count the data item up or down; move right or left selects between the data items. If using the LTC 8555 Series keyboard, press **[Enter]** to update the date displayed on all system monitors. Press **[User]** to exit the mode.

### 13.1.10 User Function 9 -

#### Set Camera ID

**User Function 9** permits entry of a 16-character camera identification message. This message appears on the video monitor display whenever the specific camera is called up for viewing. If desired, this message can be used to identify the particular scene being viewed. Refer to *Section 15*, the *CHARACTER ROM*

*TABLES* for the various characters available. After entering the mode, users with priority level 1 can use the joystick to move right or left to select the character to be changed. The selected character will be identified by a box with a question mark inside it. The first line of the video monitor screen indicates the code number of the character selected. Move the joystick up or down to step through the **Character ROM** table, or enter the character's number (as identified in the tables) via the numeric keypad, and press **[Enter]**. Once the title has been set, press **[Enter]** to store it to memory. If using the LTC 8555 Series keyboard, press **[User]** to exit the mode.

### 13.1.11 User Function 10 -

#### Change USER Password

**User Function 10** allows an operator to change system access passwords. This feature is only required in systems where the system installer has enabled keyboard login and the password security feature. After entering the mode, the video monitor display prompts for the current password OLD PASSWORD. Enter the current user password via the numeric keypad, and press **[Enter]**. If the system does not accept the old password, the system remains at this prompt. If the entered password is valid, the display changes to the **NEW PASSWORD** prompt for entry of the new password (up to 6 numerals) via the numeric keypad, then press **[Enter]**. Leave this step blank if no password is desired. If none is used, at logon, press **[Enter]** at the **P** prompt. To safeguard against typographical errors, the system prompts **VERIFY PASSWORD** requiring reentry of the new password. If the entered passwords do not agree, the system prompts for reentry and verification of the new password. If the two password entries agree, the video monitor prompt indicates **PASSWORD UPDATED**. Press **[User]** to exit the mode.

### 13.1.12 User Function 11 -

#### Select Time / Date Format

**User Function 11** can be used by priority level 1 to select time and date format used throughout the system. The 2 formats of time available are - 12-hour mode and 24-hour mode. The date is available in a **MM-DD-YY** format (U.S.), a **DD-MM-YY** format (Int'l), and a **YY-MM-DD** format (Asian). After entering the mode, move the joystick up or down to select the desired format. If using the LTC 8555 Series keyboard, press **[Enter]** to convert the system to the format chosen, then press **[User]** to exit the mode.

### 13.1.13 User Function 12 - Default All Monitor Overlays

**User Function 12** can be used by users with the priority level 1, to reset all monitor overlays to default characteristics; bottom center of screen, and full brightness. After entering the mode, press **[Enter]** to reset all monitor overlays. If using the LTC 8555 Series keyboard, press **[User]** to exit.

### 13.1.14 User Function 13 - Print System Configuration Tables

Users with priority level 1 can use this function to print the contents of the various tables programmed. Move the joystick up and down to select a table, then press **[Enter]** to send it to the printer port. If using the LTC 8555 Series keyboard, press **[User]** to exit.

### 13.1.15 User Function 14 - Reserved Function

### 13.1.16 User Function 15 - System Reset

The system may be reset from the keyboard by users with priority level 1. After entering this mode, the video monitor screen indicates **RESET SYSTEM**. Enter the password via the numeric keypad, and press **[Enter]**. The system will then reset. If using the LTC 8555 Series keyboard, press **[User]** to exit the mode without resetting the system.

NOTE: The system should be reset whenever a change is made on the main CPU module's DIP switches.

Alternatively, the main power to the CPU bay may be switched off for 10 seconds, then restored. Depending on the size and complexity of the system, several seconds may be required before operation is restored. This time is due to the amount of initialization tasks being performed, and is considered normal.

### 13.1.17 User Function 16 - Time Event Enable/Disable

Users with priority level 1 can use this function to enable or disable any of the programmed time event functions. Up to 64 time event functions can be programmed with the optional LTC 8059/00 MCS for Windows, or the LTC 8850/00 GUI software. Moving the joystick up and down steps through a table of the 64 time events. If an event has been programmed, moving the joystick to the right enables the event, and to the left disables it. The current status of an enabled time event is displayed by this user function.

### 13.1.18 User Function 17 - Set Monitor ID

**User Function 17** can be used by users with the priority level 1, to enter a (12-character) monitor identification message for display in the top line of the monitor overlay display on any system monitor(s). This monitor title will be visible on the display regardless of the camera currently being viewed. This message can be used to identify the particular monitor or a group of cameras assigned to this monitor. Refer to *Section 15, CHARACTER ROM TABLES*, for the available characters. After entering the mode, the joystick is moved right or left to select the character to be changed. The selected character is identified by a box with a question mark inside it. The first line of the video monitor display indicates the code number of the character selected. Move the joystick up or down to step through the **Character ROM** Table, or enter the character's number identified in the Tables via the numeric keypad, then press **[Enter]**. Once the monitor title has been set, press **[Enter]** to store it to memory. If using the LTC 8555 Series keyboard, press **[User]** to exit the mode. The user may select between this monitor message and the status display by using the **User 5 Function** described above.

### 13.1.19 User Function 18 - Print Sequence

Use this function to print the contents of a programmed sequence. Users with priority level 1 can use the joystick to select the desired sequence, then press **[Enter]** to print it to the printer port. Only those sequences currently existing in memory will be shown in the list. If using the LTC 8555 Series keyboard, press **[User]** to exit.

### 13.1.20 User Function 19 - Select Alarm Response

Users with the priority level 1 can use this function to reset the system alarm configuration tables to one of these predefined alarm response modes: **BASIC**, **AUTOBUILD**, or **SEQUENCE & DISPLAY**. Move the joystick up or down to select the desired mode, then enter your user password on the numeric keypad, and press **[Enter]** to update the alarm system. If using the LTC 8555 Series keyboard, press **[User]** to exit.



### 13.1.21 User Function 20 - Select Printer Verbosity

Priority level 1 users can use this function to select between print modes; **Limited Printing** and **Full Printing**. This selection determines the amount of information printed during alarm processing. Both modes print alarm activation and deactivation messages, but **Full Printing** goes into much more detail. Use the joystick to select the desired mode, then press **[Enter]**. If using the LTC 8555 Series keyboard, press **[User]** to exit without changing the print mode.

### 13.1.22 User Function 21 - Designate Alarm Monitor Type

Priority level 1 users can use this function to designate the monitor currently controlled by the keyboard as either a STEP monitor or a REVIEW monitor. This function can only be used in the predefined **SEQUENCE & DISPLAY** alarm response mode (see *Section 11, ALARM INFORMATION*) to select which monitor is the STEP (also called SEQUENCE) monitor, and which is the REVIEW (also called DISPLAY or CONTROL) monitor. To designate a monitor as the STEP or REVIEW monitor, enter **User Function 21**, then move the joystick up or down to select the monitor type. Enter your password on the keyboard and press **[Enter]**. If using the LTC 8555 Series keyboard, press **[User]** to exit. After selecting new STEP and REVIEW monitors, the previous ones may be disarmed (see *Section 12.5.3, Arm/Disarm Monitor instructions*).

### 13.1.23 User Function 22 - Select Control Code Format

This function designates whether variable speed pan/tilt and zoom commands are enabled (**Factory Default Setting**). In most cases, there is no need to disable this function. If it becomes necessary to enable or disable variable speed operation, users with priority level 1 have this capability. Move the joystick up or down to select the desired setting, then press **[Enter]**. If using the LTC 8555 Series keyboard, press **[User]** to exit.

### 13.1.24 User Function 23 - Display CPU Software Version Number

Users can use this function to display the revision number of the Allegiant's CPU software on the monitor screen.

### 13.1.25 User Function 24 - Set Positions on All Monitor Displays

This function is similar to **User Function 4**, except it changes the monitor display positions of all monitors in the system.

After entering **User Function 24**, use the joystick to position the display as required on the monitor controlled by the keyboard. Press **[Enter]** to store and change all system monitor displays to this position. If using the LTC 8555 Series keyboard, press **[User]** to exit.

### 13.1.26 User Function 25 - Set Brightness on All Monitor Displays

This function is similar to **User Function 5**, except it changes the monitor display brightness of all monitors in the system.

The white portion of the characters on the video monitor displays may be made brighter or dimmer via the **User Function 25**. Move the joystick up to increase brightness, or down to decrease brightness. Once the display on the monitor that the keyboard is currently controlling is adjusted, press **[Enter]** to change all system monitors to the same setting. Press **[User]** to exit the mode.

The **User Function 25** mode can also select either the **status** display or a 12-character **monitor message** to appear in the first line of the monitor display. The **status** display indicates alarm, sequence, and lockout information regarding the monitor. The **monitor message** is a stationary display; the display will not change as video is switched from camera to camera on the monitor. After entering the mode, move the joystick left to select the **monitor message** format, or right to select the **status** format on the monitor the keyboard is controlling. Press **[Enter]** to change all system monitors to the same setting. If using the LTC 8555 Series keyboard, press **[User]** to exit.

### 13.1.27 User Function 26 - Set Display Option On All Monitors

This function is similar to **User Function 6**, except it selects the monitor display option of all monitors in the system. The **User Function 26** mode allows removal of the time and date, the left side of the display, or to remove the entire display from the system monitors. Move the joystick down to blank the time and date from the screen. This is sometimes desirable when a VCR with its own time and date is being used. Move the joystick up to add the time and date back again.

Move the joystick left to blank the left side of the display from the monitor and right to return it. Refer to **User Function 5** or **25** to verify brightness level. Press **[Enter]** to update all system monitors to the selected format. If using the LTC 8555 Series keyboard, press **[User]** to exit.

### 13.1.28 User Function 27 - Select Keyboard Login

This function controls the system's keyboard login feature. Move the joystick up or down to select the mode for the system to function in. If the login feature is enabled (**MUST USE KBD PWD** is selected), the system keyboards require each user to login and logoff the system. All users are required to enter a user number and correct password to interact with the system. If the login feature is disabled (**NO KBD PWD LOGIN** is selected), system keyboards are always online with the system.

Once selection is made, exit the **User Function** mode and reset the system either via keyboard **User Function 15**, or by removing and restoring the main AC power to the system. Once the system has been reset, the **keyboard login** function will be active and all system keyboards will need to be logged in to access the system.

### 13.1.29 User Function 28 - Select Console Login

This function controls the system's external **Console port login** feature. After entering the mode, move the joystick up or down to select the mode in which the system should function. If the login feature is enabled (**MUST USE CON PWD** is selected), any external PC or other computing device will be required to login to communicate with the system. External computing devices are required to enter a user number and correct password. If the **Console login** feature is disabled (**NO CON PWD LOGIN** is selected), the Console port is available for communication.

Once the selection is made, exit the **User Function** mode and reset the system, either via keyboard **User Function 15** or by removing and restoring the main AC power to the system. Once the system has been reset, the **Console login** function is active, and all external computing devices need to login to access the system.

### 13.1.30 User Function 29 - Reset RS-232 Parameters to Default

This function returns the system's external RS-232 ports to a known default state. After entering the mode, enter a valid password. The system will reset after placing the RS-232 protocols back to the default state. Refer to the *Section 9, FACTORY DEFAULT SETTINGS* for additional information.

### 13.1.31 User Function 30 - Set Console RS-232 Parameters

Priority level 1 users can select the RS-232 baud rate and handshake options for the system's Console port, via this function. Upon entry to this mode, the current settings are displayed. Move the joystick up/down to select the baud rate, and left/right to select the handshake option. After being changed, the port is also automatically set to eight data bits, no parity, and one stop bit. Once new settings have been selected, enter the user password and press **[Enter]**. If using the LTC 8555 Series keyboard, press **[User]** to exit.

### 13.1.32 User Function 31 - Set Printer RS-232 Parameters

Priority level 1 users can select the RS-232 baud rate and handshake options for the LTC 8300 system's Printer port, via this function. Upon entry to the mode, the current settings are displayed. Move the joystick up/down to select the baud rate, and left/right to select the handshake option. After being changed, the port is also automatically set to eight data bits, no parity, and one stop bit. Once new settings have been selected, enter the user password and press **[Enter]**. If using the LTC 8555 Series keyboard, press **[User]** to exit.

### 13.1.33 User Function 32 - Reserved Function

### 13.1.34 User Function 33 - Display User Number and Priority

This function displays the current user's number and priority level on the monitor screen. The user number will be displayed on the top line and the user's priority level will be displayed on the bottom line of the monitor screen. If using the LTC 8555 Series keyboard, press **[User]** to exit.

### 13.1.35 User Function 34 - Camera Indicator

Priority 1 users can use this function to enable an on-screen indicator to identify a pan/tilt equipped camera. Move the joystick up or down to select **DISP CAM CONTROL** or **NO CAM CONTL DISPL**. Press **[Enter]** to activate your selection. When enabled, cameras identified as controllable (via **User Function 35** or the optional PC software package), show a  $\leftrightarrow$  in the middle of the first line of monitor text.

### 13.1.36 User Function 35 - Controllable Cameras

Priority 1 users can use this function to select camera sites equipped with pan/tilt devices. Move the joystick up or down to select the camera number, and left or right to select **FIXED** or **MOVABLE**. **User Function 34** or the optional PC software package enables or disables the display of the controllable camera indicators on the system monitor displays.

### 13.1.37 User Function 36 - Select Crosspoint Data

Priority 1 users can use this function to select options for accessory device data that can be sent out the biphas control port. Move the joystick up or down to select **XPOINT DATA**, **ALARM XPOINT**, or **PHYSICAL CAMERA NUMBER**, and left or right to enable/disable the selected option. These options need only be enabled when Switcher Follower accessory devices are being used in the system.

### 13.1.38 User Function 37 - R/D Address Mode

Priority 1 users can use this function to select whether the biphas control data commands will be addressed using the cameras' **logical** numbers or physical indexes in the camera table. Move the joystick up or down to select **LOGICAL** or **PHYSICAL** and press **[Enter]** to activate your selection. If this option is set to **LOGICAL**, receiver/drivers should be addressed using the cameras' logical identification number. If it is set to **PHYSICAL**, receiver/drivers should be addressed using the cameras' physical number.

### 13.1.39 User Function 38 - Printer Port Mode (LTC 8300 Series only)

This function allows configuration of the system's **PRINTER** port, for use with a Console Port Expander accessory device. Priority 1 users can move the joystick up or down to select the Printer port function; **NORMAL** or **EXPANDED**. Press **[Enter]** to activate your selection. You must reset the system for this setting to take effect.

### 13.1.40 User Function 39 - Select DIU Interface Port

Priority 1 users can use this function to select the switcher's interface port to be connected to an external Allegiant Bilinx Data Interface unit accessory unit. Move the joystick up or down until the desired port for use as a data interface (DIU) is displayed. Press **[Enter]** to configure the port. If using the LTC 8555 keyboard, press **[User]** to exit the mode.

### 13.1.41 User Function 40 - Vertical Sync Adjust

Priority 1 users can use this function to synchronize the vertical switching action of the switcher to the camera currently selected on the monitor. Press either **[NEXT]** or **[PREVIOUS]** to synchronize the phase delay of the system to the camera signal. The system may temporarily stop functioning for 1 or 2 seconds while the adjustment is being made. The current phase delay setting will be displayed on the bottom line of the monitor text.

### 13.1.42 User Function 41 - Cache Remote Cameras

This function is only applicable to Allegiant Satellite systems that employ a multi-level cascaded system configuration. Priority 1 users can eliminate generation of repetitive Satellite commands (that could cause undesirable operation) by disabling the remote camera cache feature using this function. After entering the mode, move the joystick up or down to select the desired option. Enter a valid password, and press **[Enter]**. After a change is made, the system must be reset either via **User Function 15** or by temporarily removing AC power to the unit.

### 13.1.43 User Function 42 - Keyboard Login Auto-off Mode

Priority 1 users can use this function to select a keyboard logoff feature to automatically log a keyboard off after a preselected time of inactivity. After entering the mode, move the joystick up or down to select the desired time period. Enter a valid password, and press **[Enter]**. If using the LTC 8555 keyboard, press **[User]** to exit the mode.

### 13.1.44 User Function 43 - CPU Battery Status

Use this function to view the condition of the batteries used to backup CPU memory. Once the function is entered, the condition is displayed on the monitor text display. If using the LTC 8555 keyboard, press **[User]** to exit the mode.

### 13.1.45 User Function 99 - User Function Index

This function is an index listing of all **Keyboard User Functions**. Move the joystick up or down to view an abbreviated description of the function number currently shown in the first line of the monitor display.

## 14.0 MAINTENANCE INFORMATION

THE ALLEGIANT SYSTEM IS DESIGNED TO PERFORM FOR LONG PERIODS OF TIME WITH LITTLE OR NO MAINTENANCE. OCCASIONALLY, KEYBOARD CLEANING OR CPU BATTERY REPLACEMENT MAY BE NECESSARY. INSTRUCTIONS ARE PROVIDED IN THIS SECTION.

### 14.1 Cleaning the Keyboard

The keyboard may be cleaned when necessary, by temporarily removing it from the system and wiping it with a damp cloth. If a conventional spray cleaner is required, spray the cloth first, then wipe off the surfaces. Do not use petroleum-based cleaners or those containing benzene, trichlorethylene, ammonia or acetone, which could damage plastic surfaces.

### 14.2 Replacement of Memory Backup Batteries

The circuit board's lithium batteries only require attention when replacement is necessary. The batteries enable RAM memory to retain its contents for up to a year without the unit being powered. Since these batteries are not used while the AC power is on, several years of service should be expected before replacing them is necessary.

When the batteries have reached the end of their useful life, the Time and Date portion of on-screen monitor displays alternate with *?? ?? ??*. This display informs the user that the CPU batteries must be replaced. The front panel of the unit must also provides LED indication of a low battery condition.

The memory backup batteries are located on the CPU module. Refer to the *INSTALLATION PROCEDURE, Section 6* for information on removing the unit cover to access the CPU module.

The two batteries are mounted on the left edge of the circuit board. Insert a small flat-blade screwdriver into the slot on one of the battery holder sockets and gently pry the battery from the holder until it can be removed by your fingers. Replace the old battery with the new battery by lifting the retaining clip up while inserting the battery into the socket. Ensure that the negative side of the battery contacts the socket by seating the battery until it is somewhat flush with the battery holder. Repeat this procedure for the other battery.

Reprogramming of the system's time and date and sequences must now be reentered. Other system-programmed data (camera titles, alarm configurations, user lockout data etc.), are stored in nonvolatile memory, and should be unaffected.

## 15.0 CHARACTER ROM TABLES

000	001	002	003	004	005	006	007	080	081	082	083	084	085	086	087
008	009	010	011	012	013	014	015	088	089	090	091	092	093	094	095
016	017	018	019	020	021	022	023	096	097	098	099	100	101	102	103
024	025	026	027	028	029	030	031	104	105	106	107	108	109	110	111
032	033	034	035	036	037	038	039	112	113	114	115	116	117	118	119
040	041	042	043	044	045	046	047	120	121	122	123	124	125	126	127
048	049	050	051	052	053	054	055	128	129	130	131	132	133	134	135
056	057	058	059	060	061	062	063	136	137	138	139	140	141	142	143
064	065	066	067	068	069	070	071	144	145	146	147	148	149	150	151
072	073	074	075	076	077	078	079	152	153	154	155	156	157	158	159

(continued on next page)



160	161	162	163	164	165	166	167
168	169	170	171	172	173	174	175
176	177	178	179	180	181	182	183
184	185	186	187	188	189	190	191
192	193	194	195	196	197	198	199
200	201	202	203	204	205	206	207
208	209	210	211	212	213	214	215
216	217	218	219	220	221	222	223
224	225	226	227	228	229	230	231
232	233	234	235	236	237	238	239
240	241	242	243	244	245	246	247
248	249	250	251	252	253	254	255



## 16.0 ERROR MESSAGES

Error	Description	Error	Description
<b>Error 01 - Invalid camera request</b>	The camera number entered from the keyboard does not exist. If using the optional LTC 8059/00 MCS or the LTC 8850/00 GUI software, ensure that the number exists in the Camera Identification table. Download the table to be sure.	<b>Error 20 - Acknowledge denied</b>	<b>ACKNOWLEDGE</b> has been pressed by a user without authority to acknowledge alarms.
<b>Error 02 - Invalid monitor request</b>	The monitor number entered from the keyboard does not exist. Enter a valid monitor number.	<b>Error 21 - Incorrect acknowledge</b>	To properly acknowledge an alarm event, the keyboard must be switched to a monitor that is displaying the alarms.
<b>Error 03 - Locked remote device</b>	The remote device requested cannot be controlled because it is locked by a user with equal or higher priority. Check with the other users or request that a higher priority user unlock the remote device.	<b>Error 22 - Acknowledge disabled</b>	Alarms on this monitor cannot be acknowledged because that capability has been disabled by the system programmer.
<b>Error 04 - Monitor locked</b>	The monitor requested cannot be accessed because it is locked by a user with equal or higher priority. Check with the other users or request that a higher priority user unlock the monitor.	<b>Error 23 - Camera not in alarm</b>	The camera displayed on the monitor is not an alarm video; only alarm-generated video can be acknowledged.
<b>Error 05 - Remote device access restricted</b>	Remote is locked out by Remote Lock Out table.	<b>Error 24 - Keyboard not enabled for acknowledge</b>	This keyboard may not acknowledge alarm video on this monitor; it has been disabled by the system programmer.
<b>Error 06 - Monitor access restricted</b>	Monitor is locked out by Monitor Lock Out Table.	<b>Error 25 - Alarm switcher running</b>	Alarm video may only be acknowledged if the alarm switcher is not running; press <b>HOLD</b> to stop the switcher.
<b>Error 10 - Access denied</b>	A function was requested that requires a higher user priority. Only a Priority 2 user or a supervisor with Priority 1 may access this function.	<b>Error 50 - SEQUENCE not available</b>	The user tried to load a switcher sequence that does not exist. This is a good way to tell from the keyboard, which sequence numbers are unused when desiring to add one.
<b>Error 11 - Access denied</b>	A function was requested for which your user priority is too low. Only a supervisor with Priority 1 may access this function.	<b>Error 51 - SEQUENCE not available</b>	A request was made to load an <b>ABSOLUTE</b> sequence without the keyboard being on one of the monitors in that sequence. Because inadvertent loading of monitors should be avoided, the user is required to switch his keyboard to one of the monitors used by the sequence. The <b>PROGRAM</b> mode may be used to review which monitors are used in the sequence.
<b>Error 15 - Invalid user function</b>	The function number requested from the keyboard is invalid. Refer to the <b>User Function</b> table for a listing of the valid user function numbers.	<b>Error 52 - SEQUENCE request</b>	A request was made to load a <b>RELATIVE</b> sequence on a monitor number that is too high. The monitors used by the sequence would extend past the highest monitor. Try switching to a lower monitor number before loading the sequence.
		<b>Error 53 - Switcher empty</b>	The user has tried to control a sequence using <b>NEXT</b> , <b>PREV</b> , <b>RUN</b> , or <b>HOLD</b> without a sequence having been loaded.

Error	Description	Error	Description
<b>Error 55 - SEQUENCE priority</b>	The switcher sequence being requested or cleared requires monitors that are in use by a user of equal or higher priority. Contact a user with higher priority, or have the system administrator clear the monitors in question.	<b>Error 80 - Trunk not available</b>	An attempt was made to access a remote camera connected to a satellite system, but no unused trunk lines are currently available.
<b>Error 56 - SEQUENCE request</b>	The user has tried to load a sequence that is being edited in the <b>PROGRAM</b> mode. Once editing has been completed, the sequence may be loaded.	<b>Error 81 - Satellite Trunk Seized</b>	The camera currently viewed has changed because an operator with a higher priority has selected a different camera that seized the trunk line from the satellite.
<b>Error 58 - SEQUENCE request</b>	The sequence being requested is a Relative sequence, and the user is only permitted access to Absolute sequences.	<b>Error 89 - Internal stack error</b>	A stack overflow has occurred within the system. Report this to the manufacturer.
<b>Error 60 - PROGRAM request</b>	The user has tried to program a sequence that is currently running. The sequence must first be stopped before any editing can be performed.	<b>Error 90 - Keyboard entry undefined</b>	The keyboard entry is not defined. Check the appropriate section of the instruction manual for the desired operation and try again.
<b>Error 62 - PROGRAM request</b>	The user has tried to program a new sequence when the system is out of sequence memory space. Delete unused sequences and then program the new sequence.	<b>Error 92 - Keyboard entry out of range</b>	The data entered for a valid command was not in the permitted range. Check the appropriate section of this instruction manual for the acceptable ranges for the command in question and try again.
<b>Error 63 - PROGRAM request</b>	Some other user is already programming a sequence on this monitor.	<b>Error 94 - Keyboard entry invalid</b>	An invalid character has been received from the keyboard, usually caused by a communication error. Verify that the keyboard-to-system cable is securely connected.
<b>Error 70 - Monitor not allocated to alarm monitor group</b>	This monitor cannot be used for alarm operations; it has not been designated as alarm-capable by the system programmer.	<b>Error 95 - Keyboard entry incomplete</b>	The control sequence sent from the keyboard was incomplete, usually indicating a communication error. Verify that the keyboard-to-system cable is not producing an intermittent connection.
<b>Error 71 - Step monitor required</b>	A group of alarm monitors may not have an armed Review (display) monitor without having armed Step (sequence) monitors.	<b>Error 96 - * (STAR) undefined</b>	The * key has been pressed, but there is no definition for this button.
<b>Error 78 - Must enter alarm number</b>	A specific alarm number must be entered when arming or disarming an alarm.		

## 17.0 TROUBLESHOOTING

Allegiant systems are designed to perform reliably for long periods of time. All circuitry consists of state of the art components designed around a single bay concept. If troubleshooting becomes necessary, follow these guidelines:

Problem	Description/Solution
<b>System Checkout</b>	
Front panel power LED is not lit.	<ul style="list-style-type: none"> <li>Check the main AC supply source.</li> </ul>
Green STATUS LED on front panel is not blinking and BATTERY LED is off.	<ul style="list-style-type: none"> <li>Remove power from unit for 30 seconds. Apply power and verify that the STATUS LED is blinking. If still not functional, seek service.</li> <li>If Red BATTERY LED is lit, replace microprocessor board batteries. Follow procedure outlined in <i>Maintenance Information Section</i>.</li> </ul>
<b>Keyboard Checkout</b>	
No keyboard display indicators.	<ul style="list-style-type: none"> <li>Check interconnect cable for cut or broken wires between the keyboard and the main bay and replace cable if necessary.</li> <li>Relocate keyboard connector on the bay to another keyboard input port.</li> <li>Replace keyboard.</li> </ul>
Keyboard indicators lit but keyboard is inoperative.	<ul style="list-style-type: none"> <li>Verify that the keyboard is logged on to the system (if logon feature is enabled).</li> <li>Check interconnect cable for cut or broken wires between the keyboard and the main bay and replace cable if necessary.</li> <li>Relocate the keyboard connector on the bay to another keyboard input port.</li> <li>Replace the keyboard.</li> </ul>
Limited keyboard functions.	<ul style="list-style-type: none"> <li>If possible, perform local the keyboard test described in <i>Section 13, KEYBOARD USER FUNCTIONS</i> to verify operation of all keys. If this local test cannot be performed, replace the keyboard.</li> <li>LTC 8059/00 MCS for Windows package users or LTC 8850/00 GUI software users should refer to lockout tables to determine if the problem is related to user restriction tables. If table settings are verified and no discrepancies are found, replace the keyboard.</li> </ul>
Keyboard Joystick not centered.	<ul style="list-style-type: none"> <li>If the analog joystick of the system keyboard becomes un-centered due to normal wear, it can be recalibrated. If using the IntuiKey keyboard, go to the <b>Keyboard Control</b> menu and press <b>Joystick Auto Calibrate</b>. If using the LTC 8555 Series keyboard, refer to <b>User Function 1</b> procedure.</li> </ul>
<b>Video Monitor Display Checkout</b>	
No video display on any monitor.	<ul style="list-style-type: none"> <li>Verify proper CPU operation as described above under System Checkout.</li> </ul>
No video display on some monitors.	<ul style="list-style-type: none"> <li>Verify that an operational camera is selected on suspect monitors.</li> <li>Confirm that the monitor is operational.</li> <li>Check the monitor coax connections.</li> <li>Verify that the coax connection is to the correct monitor output on the rear of the bay.</li> </ul>
Poor video on monitor.	<ul style="list-style-type: none"> <li>Check the monitor for proper termination.</li> <li>Check operation of a known good camera, directly to monitor.</li> </ul>
Partial or no on-screen alphanumeric display.	<ul style="list-style-type: none"> <li>Check user-selectable brightness feature (via <b>User 5 Function</b>) and then verify that alphanumeric display has been enabled (via <b>User 6 Function</b>). Position the overlay with <b>User 4 Function</b>.</li> </ul>
Time and Date portion of the on-screen display alternates with ?? ?? ??, and the LED on the front panel indicates a low battery condition.	<ul style="list-style-type: none"> <li>Replace CPU batteries.</li> </ul>

Problem	Description/Solution
<b>Remote Receiver/Driver Functions Inoperative</b>	
All receiver/drivers and functions inoperative.	<ul style="list-style-type: none"> <li>Verify that the CODE LED indicator on the front panel lights during P/T/Z control actions. If not, the unit requires service.</li> </ul>
Individual receiver/driver nonoperative.	<ul style="list-style-type: none"> <li>Check the Green LED code indicator inside the receiver/driver box. If not lighting, check shielded twisted-pair cable between the unit and receiver/driver box.</li> <li>Confirm that the camera address setting in the receiver/driver corresponds to the camera number selected by the keyboard.</li> <li>Perform internal receiver/driver local test to verify operation its receiver/driver circuitry and the pan/tilt/zoom wiring.</li> </ul>
AutoDome Series cameras are not operating in a variable speed fashion.	<ul style="list-style-type: none"> <li>Verify that CPU DIP switch 7 is selected for variable speed mode.</li> </ul>
<b>No Alarm Response</b>	
No system alarms are operative.	<ul style="list-style-type: none"> <li>Verify that the Alarm LED on the front panel lights when the unit is in alarm. If not, verify that alarm programming is correctly enabled.</li> </ul>
Individual cameras/monitors not responding when alarmed.	<ul style="list-style-type: none"> <li>Ensure that the desired cameras are properly armed on the appropriate armed system monitors.</li> <li>Verify that the alarming device and the cable to the unit's alarm interface connections are intact.</li> </ul>
Incorrect system alarm response.	<ul style="list-style-type: none"> <li>Verify that the desired alarm response mode has been selected.</li> <li>Refer to <i>Section 13, KEYBOARD USER FUNCTIONS</i> for instructions.</li> </ul>
Alarms cannot be reset.	<ul style="list-style-type: none"> <li>Power off/on unit to clear all alarms. (Any alarms that re-initiate are still active.)</li> <li>Verify alarm response and user settings for alarm acknowledge authority.</li> <li>Remove alarm connections to rear of unit. If alarms are still present, investigate possibility that alarm input polarity has been changed by the installer using "CCL" commands.</li> </ul>
<b>CPU Software Version Numbers</b>	
During the system evolution, new CPU software versions will be released. Some troubleshooting cases require Factory Technical Support personnel to ask for the version of the CPU. To obtain a CPU software version:	<ul style="list-style-type: none"> <li>Using a system keyboard, an operator with a priority level 1 can enter keyboard <b>User Function 23</b>. Press <b>[User]</b>, then <b>Enter 23</b> using the numeric keypad, and press <b>[Enter]</b>.</li> <li>The CPU version number will be displayed on the overlay of the monitor currently being controlled by the keyboard. Record this number for future reference.</li> </ul>

## 18.0 GLOSSARY OF TERMS

Term	Definition
AUXILIARY	An auxiliary is an additional function of the remote receiver/driver which permits on/off control of outputs available to the user. In the Allegiant system, four relay outputs are available, which can be configured for contact closures, 24 VAC output, or LINE voltage output. Additionally they can also be set to activate either momentarily, or in a latching mode.
COMMAND SCRIPT	A unique feature of the Allegiant system wherein a section of nonvolatile memory can be used to store specialized factory programming. This program then provides custom features, not ordinarily obtainable.
DITHER	A receiver/driver feature providing added protection to very low light level cameras, by periodically panning a few degrees left and right automatically.
LOCKOUTS	Switcher/controller system ability to restrict access to certain system functions/features. The Allegiant system modes of lockouts are: <ul style="list-style-type: none"> <li>• By operator level, allowing a higher priority level operator to lockout lower level operators from viewing or controlling specific cameras.</li> <li>• By MCS setups to: <ol style="list-style-type: none"> <li>1. Restrict operators/keyboards from viewing/accessing any camera.</li> <li>2. Restrict operators/keyboards from controlling/accessing any pan/tilt.</li> <li>3. Restrict operators from using certain keyboards.</li> <li>4. Restrict operators/keyboards from accessing certain monitors.</li> </ol> </li> </ul>
LOGON, LOGOFF	A selectable Allegiant feature requiring operators to enter a User number and optional password into the keyboard prior to access.
MATRIX SWITCHING	The ability of a switching system to display any camera on any monitor, or the same camera on all monitors.
PHASED CAMERAS	These are properly integrated cameras, giving a roll-free video display when switching from one camera to the next in a sequential switcher system. Phased cameras are the result of line-locked cameras powered from the same AC power, externally synchronized, or vertically phased adjusted on cameras equipped with this option.
PRE-POSITION	The ability to store the position of a pan/tilt/zoom lens, so that the desired scene can later be automatically recalled. With the Allegiant system, there can be multiple preset scenes stored for each pan/tilt camera. For each scene, the pan, tilt, zoom, and focus settings are stored.
SalvoSwitching	The ability of the Allegiant system to switch multiple video monitors as a synchronized group. Since multiple monitors switch together, multiple scenes of an area or zone are viewable before switching to the next area.
SEQUENCE	A series of camera scenes that can be preprogrammed to switch automatically. The Allegiant system can store up to 60 sequences, each one capable of having random camera order, individual camera dwell times, and SalvoSwitching steps.
TIME EVENT	An Allegiant system feature (available with the LTC 8059/00 MCS for Windows or the LTC 8850/00 GUI software) enabling various system functions to periodically be activated automatically. Event functions (monitor message broadcasts, sequence and switching operations, receiver/driver actions, message printing, alarm settings, and execution of custom factory programming) can be stored in the system memory for execution at a predetermined time. The task can be specified to begin on a specific year, month, day, and time, and can repeat at intervals from every five minutes to a year.
VERTICAL INTERVAL SWITCHING	Camera to camera video switching during the vertical blanking interval of the video signal. This minimizes visual switching disturbances such as rolling, jitter, video flashes, etc., and eliminates frame information loss when used with video tape machines.
VersAlarm	A flexible system of configuring alarms via the optional LTC 8059/00 MCS for Windows or the LTC 8850/00 GUI software. Multiple groups of monitors can be programmed to respond to alarm conditions in various ways. Additionally, each alarm may call up 1 to 4 cameras with user-selectable remote operations. Alarm video may also be programmed to display user-defined alarm titles on the monitor overlay display rather than the usual camera titles.

## APPENDIX A - SATELLITE SYSTEMS

A satellite system configuration is usually used for a large distributed system, or to obtain extremely large matrix sizes configured more conventionally. Typically, a single Main control site can be used to view/control cameras located both locally and at various remote satellite sites. Since many satellite sites can be linked to a single Main control site, very large, distributed systems can be achieved. If the satellite systems are located at the same site as the Main system, the result is a large conventional-type system. In a satellite configuration, the Main control site can view/control any camera in the entire system, but the remote satellite sites can only view/control cameras associated with their own site. Satellites may be configured to operate either independently or, with no local viewing/control capability.

The Main site must consist of any Allegiant Series switcher (LTC 8100, LTC 8200, LTC 8300, LTC 8500, LTC 8600, or LTC 8800). Satellite site switchers can be any Allegiant model switcher. A LTC 8780 Series Data Converter is required at each satellite site, to perform address decoding and data conversion for the switching system. If the satellite site contains pan/tilt/zoom cameras, a LTC 8569 Code Merger is also required at the satellite site. All products are standard models, and the only required option is to use either the Master Control Software for Windows LTC 8059/00 or the LTC 8850/00 GUI software package for initial programming of each Allegiant system.

Each satellite site must have an Allegiant control data line from the code distribution unit at the Main site. This data line carries all pan/tilt/zoom control commands, in addition to the switching commands generated by the Main site switcher. The control data line should be connected to a LTC 8780 Series Data Converter to provide address decoding functions for the satellite site. If operators at the satellite site are permitted to control pan/tilt/zoom-equipped cameras, a LTC 8569 Series Code Merger must be installed at the satellite site. The Code Merger combines code generated by the main site and the satellite site, so both sites have control over pan/tilt/zoom-equipped cameras located at the satellite site. The LTC 8780 Series unit can then be connected to one of the data outputs of the LTC 8569 Series unit.

One or more monitor outputs from each satellite system are used as trunk lines to link the remote sites to the Main site. The number of trunk lines from a satellite site determines the maximum number of cameras from that site that may be viewed simultaneously at the Main site. A satellite switcher can provide only as many trunk lines as it has monitor outputs.

Sufficient monitor outputs used as trunk lines must be included in remote satellite switcher sites. The Main site switcher must include sufficient camera inputs for local cameras plus trunk lines. The maximum physical number of camera inputs or monitor outputs used as trunk lines cannot exceed the capacity of the system.

A single Main site switcher can control multiple satellite sites up to its video input limit. If full matrix switching is required at the Main site, the number of trunk lines from each satellite site must equal the number of monitors connected to the Main site switcher. Multiple independently controlled Main site systems can be combined to provide large numbers of monitor outputs at the Main site. System capacities are listed below:

System Type	Max. Camera Inputs	Max. Monitor Outputs	Max. No. of Satellite Sites
LTC 8100 Series	8	2	8
LTC 8200 Series	16	5	16
LTC 8300 Series	32	6	32
LTC 8500 Series	64	8	64
LTC 8600 Series	128	16	128
LTC 8800 Series	256	64	256
LTC 8900	4096	512	256



Since Allegiant Series switchers can act as Main site switchers, they provide additional **logical** camera numbers for identifying the location of the satellite camera inputs in the system. These **logical** camera numbers can also be used to provide titles which would appear on the Main site's monitors for any remote cameras. Since each camera (anywhere in the system) must have a unique camera number, **logical** camera numbers together with **physical** camera inputs make up the total system **camera** capacity. Thus, there is a trade-off between the total number of Main site cameras and the number of inputs used as trunk lines. The more inputs used as trunk lines, the fewer there are for use as direct camera inputs.

Model No.	Maximum Number* System Cameras
LTC 8100 Series	264
LTC 8200 Series	272
LTC 8300 Series	288
LTC 8500 Series	320
LTC 8600 Series	1152
TC 8700 Series	2304
LTC 8800 Series	2304
LTC 8900 Series	4608

\*Camera inputs at all sites, plus trunk lines.

The Main site system must be programmed via the Master Control Software for Windows LTC 8059/00 or the LTC 8850/00 GUI, to identify camera trunk line inputs as well as remote satellite cameras. All systems must be configured with no duplicate camera numbers anywhere in the system.

Any alarm inputs to the Main site configured to activate satellite cameras operate normally except when limited by the number of available trunk lines. The software automatically determines trunk usage, depending on the priority level of operators currently viewing satellite cameras. Alarm inputs applied at a satellite site will NOT activate alarm video at the Main site. If the application requires alarms located at a satellite to activate video at the Main site, the Main site's LTC 8540/00 Alarm Interface unit must be remotely located. Multiple LTC 8540/00 Alarm Interfaces may be remoted via the LTC 8713 Alarm Port expander accessory, located at the Main switcher site in LTC 8800 and LTC 8900 systems. Up to 2 LTC 8540/00 Alarm Interfaces with a LTC 8713 Alarm Port Expander can be used in a LTC 8600 system. One LTC 8540/00 can be used in LTC 8500 systems. Since the LTC 8100, LTC 8200, and LTC 8300 Series contain an integral alarm interface, the remote alarm interface application does not apply.

A unique time and date synchronizing feature provided in the **Time Event** table of the MCS for Windows or the GUI software may be programmed into the Main site switcher. This permits periodic synchronizing of the time and date to all switchers in the system based on the Main site's clock.

A conceptual diagram of a satellite switching system is follows.

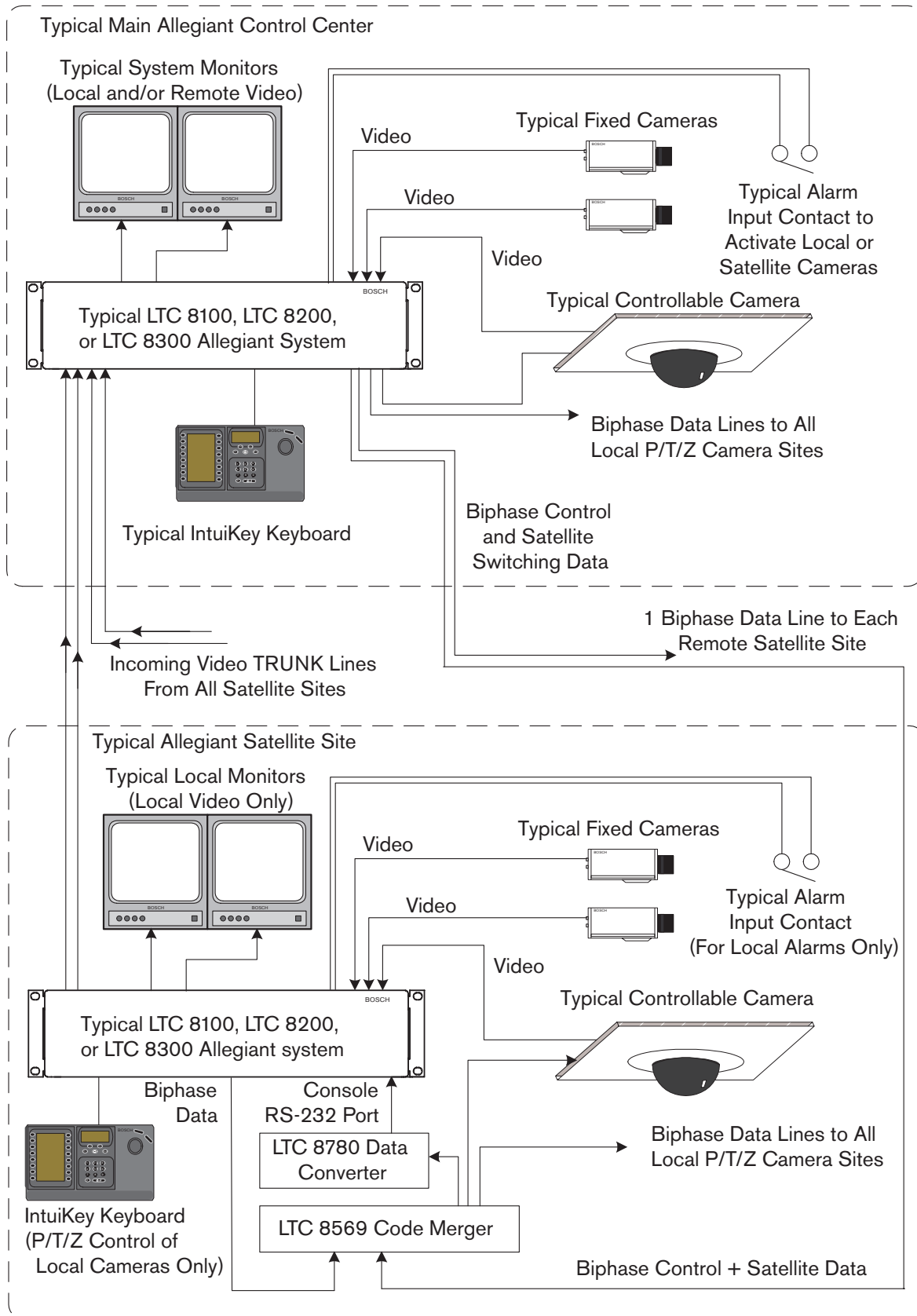

## APPENDIX B - INSTALLATION CHECKLISTS

This is a simplified guide for those already familiar with installing and programming Allegiant systems.

### 1 System Hardware Installation

Unpack equipment and verify that there is no damage.

- Set applicable CPU DIP switches to activate desired features.
- If applicable, install bay into EIA 19-inch rack (remember to remove the rubber bumper foot pads).
- Connect camera inputs and monitor outputs to appropriate connections on equipment bay(s).
- Connect system keyboards, any alarm connections, and any signal distribution connections to bay.
- Apply main AC power to the equipment.
- Verify proper system operation, then begin appropriate programming.

### 2 Satellite Configuration Hardware Installation

#### Main Site:

- Install Allegiant Series bay and appropriate accessory products accordingly. Verify biphasic control code line is run to each satellite site.
- Attach trunk line inputs, local camera inputs, and monitor outputs to the Allegiant Series bay. Apply main AC power to the equipment.
- Program the **Camera ID** table via the MCS or GUI software.
- Switch all unused monitor outputs located at the main site to display a **local** camera input.

#### Satellite Site(s):

- Install the satellite switcher and appropriate accessories.
- Connect the biphasic code line to LTC 8780 Data Converter and configure it to the desired satellite address and the switcher's baud rate.
- If necessary, program the satellite switcher for the appropriate camera titles, and any other related requirements.

### 3 Programming Via System Keyboard

- Enter the system time (**User Function 7**) and date (**User Function 8**) and Camera ID titles (**User Function 9**). If desired, adjust the monitor overlay displays (**User Functions 4, 5, and 6** or **24, 25** and **26**).
- Enter the desired Sequences.
- Configure and test the alarm response mode.

## APPENDIX C - QUICK REFERENCE CABLE INTERCONNECTIONS

### 1 System Video Connections

COAX — All video input and output connections to the Allegiant system should be made using a good grade of RG59U, RG6, or RG11U coaxial cable, using BNC connectors. Use the following guidelines for proper cable specifications:

1. Center conductor should be copper, not copper weld or steel. Use stranded wire where there will be cable movement, as with pan/tilts, elevators, etc.
2. Copper braided shield at 93% coverage or better.
3. Cable impedance of 75Ω.
4. Select cable based on a target of no more than 15Ω of the center conductor resistance. A typical value for RG59U is 15Ω per 300 m (1000 ft), therefore the maximum cable run should be no more than 300 m (1000 ft). RG11U/RG6 is typically rated for 6Ω per 300 m (1000 ft), which permits runs up to 760 m (2500 ft).
5. Use video amplifiers to extend cable distances beyond the maximum limitations listed above.

### 2 Keyboards

1. The keyboard is supplied with 3 m (10 ft) of 6-conductor phone-type cable with RJ-11 connectors. The cable plugs directly into the rear of the system's main bay on one end, and into the back of the keyboard on the other end. Both data and power for the keyboard travel over this cable.
2. An optional 30 m (100 ft) cable is also available.
3. An optional kit which permits the keyboard to be extended beyond 30 m (100 ft) is available, and uses customer-supplied shielded twisted pair. The kit consists of two breakout boxes which convert from phone-type cables to shielded twisted pair, and provide for local keyboard power. The maximum distance using 24-gauge wire (Belden 9841 or equivalent) is typically 1.5 km (500 ft).

### 3 Alarm Connections

The alarm inputs can be dry contact closures or logic levels. Connect the alarm inputs to removable screw-type terminal blocks; the use of simple twisted pair wire is acceptable.

### 4 Signal Distribution Connections

Only shielded twisted pair wire should be used between the integral distribution unit outputs and the camera site receiver/drivers. Connect the distribution unit to removable screw-type terminal blocks. Each output is rated to handle up to 8 receiver/driver loads (as in a **daisy chain** configuration) to a maximum of 1.5 km (5000 ft) using 1 mm<sup>2</sup> (18) gauge wire (Belden 8760 or equivalent).

### 5 Receiver/Drivers

CODE INPUT — The code input is supplied by the shielded twisted pair cable from the signal distribution connections. This cable is connected to a removable screw-type terminal block, which has provisions for looping the code cable to another receiver/driver.

OUTPUT CONNECTIONS — All pan/tilt and lens connections require multiconductor cable. Refer to the appropriate specification sheet for cable gauge, number of conductors required, and maximum distances allowable. The lens cables and any pre-position cables should be kept shielded from other signal wires to minimize interference.

## APPENDIX D - REAR PANEL CONNECTOR PINOUTS

### 1 Console Port RS-232 Pinouts

Pin #	Designation
1	CHASSIS GND
2	RX
3	TX
4	CTS
5	RTS
6	NO CONNECTION
7	DATA GND
8	NO CONNECTION
9	NO CONNECTION

### 2 Keyboard RS-485 Ports

Pin #	Designation
1	12 VAC
2	GND
3	-DATA
4	+DATA
5	GND
6	12 VAC

### 3 Printer Port RS-232 Pinouts

Pin #	Designation
1	CHASSIS GND
2	RX
3	TX
4	CTS
5	RTS
6	NO CONNECTION
7	DATA GND
8	NO CONNECTION
9	NO CONNECTION

The LTC 8506/00 cable (used to connect the Allegiant's CONSOLE port to an external PC) uses the following pinouts:

9-Pin Male (CONSOLE)	Allegiant Designation	9-Pin Female (PC)
1	Chassis GND	None
2	RX	3
3	TX	2
4	CTS	1
5	RTS	8
6	No Connection	None
7	Data GND	5
8	No connection	None
9	No connection	None

(pins 4 & 6 are jumpered)  
(pins 1 & 7 are jumpered)

The cable used to connect the LTC 8300's PRINTER port to a standard serial printer uses the following pinouts:

9-Pin Male (8300 Port)	Allegiant Designation	25-Pin Female (Printer)
1	Chassis GND	1
2	RX	2
3	TX	3
4	CTS	4, 8
5	RTS	5
6	GND	None
7	Data GND	7
8	GND	None
9	GND	None

(pins 6 & 20 are jumpered)







Bosch Security Systems, Inc.  
850 Greenfield Road  
Lancaster, PA 17601 USA  
Tel: 800-326-3270  
Fax: 1-717-735-6560  
www.boschsecurity.com

Bosch Security Systems B.V.  
P.O. Box 80002  
5600 JB Eindhoven  
The Netherlands  
Tele +31 40 27 87113

Bosch Security Systems Pte Ltd.  
38C Jalan Pemimpin  
Singapore 577180  
Republic of Singapore  
Tel: 65 (6) 319 3486

© 2004 Bosch Security Systems GmbH  
3935 890 12013 04-50 | December 08, 2004 | Data subject to change without notice.

Windows is a registered trademark of Microsoft Corporation.

Bilinx, Allegiant, AutoDome, SalvoSwitching, and StatelliteSwitch are registered by Bosch Security Systems, Inc. in the US patent trademark office.

# BOSCH